

Operating manual

Wireless data logging system

HD35 series



Members of GHM GROUP:

GREISINGER

HONSBURG

Martens

Delta OHM

VAL.CO

www.deltaohm.com

Keep for future reference.

TABLE OF CONTENTS

1	INTRODUCTION	4
2	SYSTEM COMPONENTS.....	5
3	INSTALLING THE SYSTEM	6
4	NETWORK MODIFICATION.....	11
5	FIXING THE HOUSING	12
6	BASE UNITS HD35AP...	14
6.1	DESCRIPTION OF VERSIONS FOR INDOOR USE.....	14
6.2	DESCRIPTION OF HD35APR DIN RAIL VERSION.....	15
6.3	DESCRIPTION OF HD35APxGMT VERSIONS FOR OUTDOOR USE.....	16
6.4	RF LEDS SIGNALS	17
6.5	AVAILABLE CONNECTIONS DEPENDING ON MODEL	17
6.6	USB CONNECTION	17
6.7	ETHERNET OR WI-FI CONNECTION.....	18
6.8	RS485 CONNECTION	19
6.9	HD35APR CONNECTIONS	20
6.10	HD35APxGMT POWER SUPPLY.....	21
6.11	4G/3G/GSM CONNECTION.....	22
6.11.1	SENDING COMMANDS TO THE BASE UNIT FROM A MOBILE PHONE	23
6.11.2	4G/3G/GPRS TCP/IP CONNECTION	26
6.12	BASE UNITS TECHNICAL SPECIFICATIONS	28
7	HD35RE... REPEATERS	30
7.1	DESCRIPTION OF HD35RE VERSION FOR INDOOR USE	30
7.2	DESCRIPTION OF HD35REW VERSION FOR OUTDOOR USE	31
7.3	CONNECTION TO THE WIRELESS NETWORK	31
7.4	ARRANGEMENT OF THE REPEATERS.....	32
7.5	REPEATERS TECHNICAL SPECIFICATIONS	33
8	HD35ED... DATA LOGGERS	34
8.1	DESCRIPTION	34
8.2	CONNECTION TO WIRELESS NETWORK.....	37
8.3	LCD DISPLAY	37
8.4	MAXIMUM, MINIMUM AND AVERAGE OF THE MEASUREMENTS (ONLY INDOOR MODELS)	38
8.5	THE MENU IN LCD DATA LOGGERS.....	38
8.5.1	THE MENU IN DATA LOGGERS WITH GRAPHIC LCD.....	38
8.5.2	THE MENU IN DATA LOGGERS WITH CUSTOM LCD	43
8.6	M12 CONNECTORS PIN-OUT.....	46
8.7	CONNECTIONS IN THE INDOOR MODEL HD35ED[G]H	48
8.8	CONNECTIONS IN THE OUTDOOR MODEL HD35ED[L]WH.....	50

8.9	CONNECTIONS IN THE OUTDOOR MODEL HD35ED[L]W-MB	51
8.10	HP712 LEVEL SENSOR CONNECTION (FOR HD35ED[L]WDPTC).....	51
8.11	CALIBRATION	52
8.11.1	CO ₂ CALIBRATION.....	52
8.11.2	DIFFERENTIAL PRESSURE CALIBRATION	54
8.11.3	RELATIVE HUMIDITY CALIBRATION	54
8.11.4	PHOTOMETRIC PROBE SENSITIVITY SETTING.....	55
8.12	WBGT INDEX MEASUREMENT (HD35ED[L]WWBGT MODEL)	56
8.13	VOLATILE ORGANIC COMPOUNDS (VOC) MONITORING (HD35ED[G]1NB...V MODEL)	60
8.14	DATA LOGGERS TECHNICAL SPECIFICATIONS	61
9	HD35ED-ALM REMOTE ALARM DEVICE.....	69
9.1	DESCRIPTION	69
9.2	CONNECTION	69
9.3	CONNECTION TO THE WIRELESS NETWORK	70
9.4	ALARM DEVICE TECHNICAL SPECIFICATIONS.....	70
10	DIMENSIONS.....	71
11	STORAGE OF INSTRUMENTS	74
12	SAFETY INSTRUCTIONS.....	74
13	PROBES AND ACCESSORIES ORDERING CODES	75

1 INTRODUCTION

The HD35 series wireless data logging system allows several physical quantities to be monitored in a large variety of application fields.

Data loggers equipped with built-in sensors or external probes are available. Models with inputs for sensors with RS485 Modbus-RTU output or standard analog sensors are also available, such as:

- Transmitters with 0÷20 or 4÷20 mA current output and 0÷50 mV, 0÷1 V or 0÷10 V voltage output (*Note*: 0÷10 V only for HD35EDWH)
- Pt100 / Pt1000 temperature sensors and K, J, T, N, E thermocouples
- Voltage-free contact output (commutations counting) or potentiometric sensors

This allows the monitoring capability of the system to be extended to countless quantities.

For each detected quantity, the user can set two alarm thresholds (high threshold and low threshold). The alarm hysteresis and delay can be configured for each quantity. The overrun of the thresholds can be indicated by an audible signal of the data logger through an internal buzzer; the alarm signal is immediately transmitted to the base unit and displayed on the PC. A wireless remote alarm module with relay output is available allowing other signaling devices (sirens, flashing lights...) or actuators to be activated. If the system is equipped with a cellular module, the alarm can be signaled also by e-mails or SMS messages.

Systems with the following transmission frequencies are available: **868 MHz** (in compliance with ETSI EN 300 220 European Directive), **902-928 MHz** (in compliance with U.S. FCC part 15 section 247 and I.C. RSS-210 Directives) and **915,9-929,7 MHz** (in compliance with ARIB STD-T108 standard).

Thanks to wireless transmission, the installation of the system is a very simple and quick operation. In addition, the user will not have to remove the data logger from its position or reach the place where the data logger is installed to download the data measured with the PC.

The correctness of the transmitted data is ensured by the **bidirectional** communication between the base unit and the remote data loggers.

HD35AP-S PC software, downloadable free of charge from the Delta OHM website, allows configuration of all system devices, display of connection status, level of the RF signal and battery charge level, data automatic download at regular intervals or manual download on request of the user. The data transferred to the PC are entered into a database.

Data loggers comply with **EN 12830** standard. The **optional HD35AP-CFR21** advanced version of the software is designed in compliance with **FDA 21 CFR part 11** recommendations: the operations are protected by access codes and a record of the performed operations is kept.

2 SYSTEM COMPONENTS

The system consists of the following components:

- **HD35AP...** base unit
- **HD35RE...** repeaters
- **HD35ED...** series of data loggers
- **HD35ED-ALM** remote alarm device

HD35AP... BASE UNIT

This device acts as an interface between the network data loggers that are positioned in the measurement sites, and the PC. It communicates wireless with the remote data loggers.

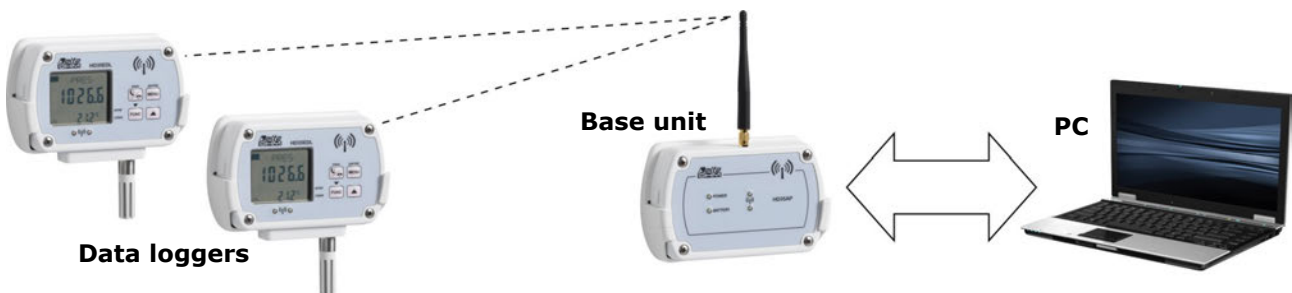

Fig. 2.1: base unit placed between data loggers and PC

HD35RE... REPEATERS

These devices are able to act as a bridge between the base unit HD35AP... and the remote data loggers HD35ED..., allowing the communication distance between data loggers and base unit to be increased. Several repeaters in cascade can be used.

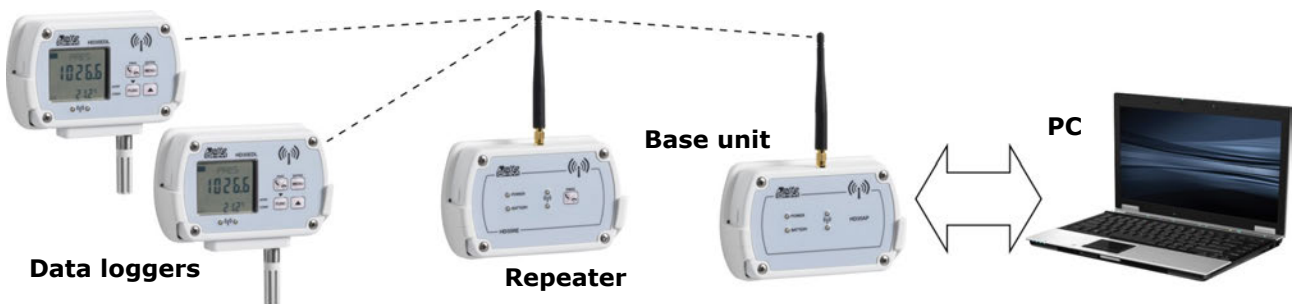

Fig. 2.2: repeater placed between data loggers and base unit

HD35ED... DATA LOGGERS

Remote devices with measurement probes. They are installed in the locations to be monitored. They acquire measurements, store them in the internal memory and send them automatically to the base unit at regular intervals or on request of the user. Versions with or without LCD display are available.

HD35ED-ALM REMOTE ALARM DEVICE

Device equipped with relay outputs that allows to activate, in case of an alarm, signaling devices (sirens, flashing lights...) or actuators.

3 INSTALLING THE SYSTEM

Before placing the devices in the final working environment, it is recommended to perform the system function test on the bench. The bench test allows also the wireless network to be configured more easily, in case the supplied system is not factory-configured.

To check and make the system operational, proceed as follows:

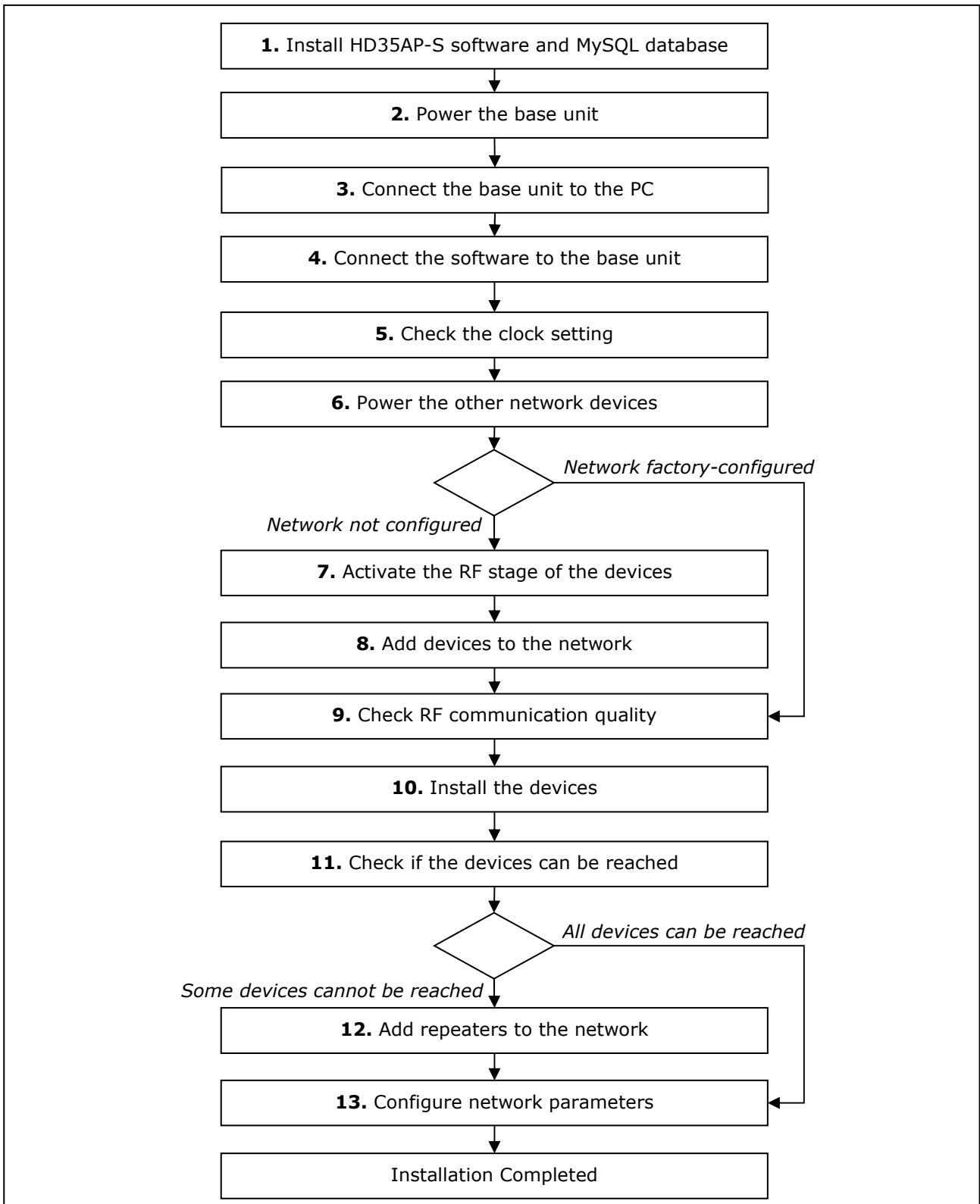

Fig. 3.1: system installation procedure

1. INSTALLING HD35AP-S SOFTWARE

Download the HD35AP-S software from the Delta OHM website. Install both HD35AP-S software and MySQL Data Base Management System (included in the package of HD35AP-S software) in your PC. Concerning the installation of MySQL, **thoroughly** follow the installation guide contained in the downloaded file.

2. POWER THE BASE UNIT

If the base unit is battery powered, insert the battery as follows:

1. Unscrew the 4 front screws of the housing and remove the back cover.
2. Attach the battery connector to the electronic board, paying attention to the correct polarity. The connector is equipped with a polarization key that prevents the possibility of a wrong insertion of the connector.

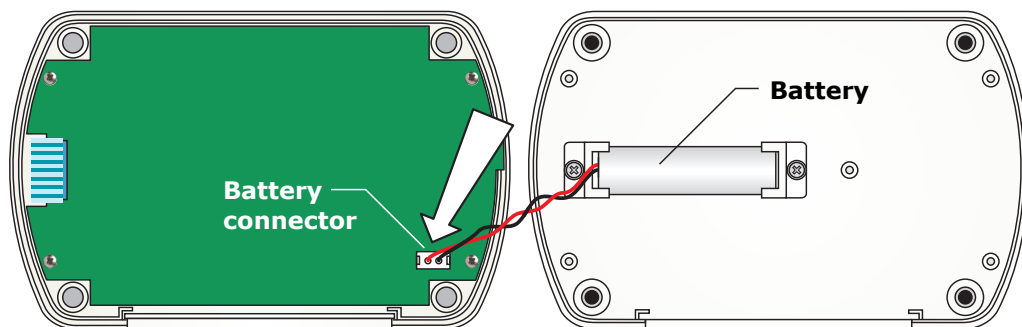

Fig. 3.2: battery in the devices in housing for internal use

3. Close the housing by fixing the 4 front screws.

Note: in some models the battery connector might be in a slightly different position.

For the base units with external power supply (HD35APR e HD35APxGMT) see the connections on pages 20 and 21. HD35APD is powered by the PC USB port.

- **Factory-configured system:** first connect the power supply of the base unit and check the clock setting. Only after this operation, connect the battery of the data loggers, so that the clock can be synchronized with the updated clock of the base unit at startup.
- **Not configured system:** at startup, data loggers don't synchronize the clock with that of the base unit, consequently it is not important to power the base unit as first.

3. CONNECTING HD35AP... BASE UNIT TO YOUR PC

The HD35AP... base unit can be connected to the USB port of a PC through the **CP31** cable (directly with USB A-type connector for HD35APD...). In this connection mode, the base unit is powered through the USB port of the PC.

The USB connection doesn't require the installation of drivers: when the base unit is connected to the PC, Windows® operating system automatically recognizes the unit as an HID (Human Interface Device) device and uses the drivers already included in the operating system.

Note: even the base units HD35APW and HD35APR, with Wi-Fi and/or Ethernet interface, must first be connected to the PC via USB through the CP31 cable for setting the parameters of the local network (e.g., for setting the IP address, for choosing the Wi-Fi or Ethernet mode, etc.).

4. CONNECT THE SOFTWARE TO THE BASE UNIT

Start the HD35AP-S software in your PC and perform the connection procedure illustrated in the chapter " *Connection to base unit* " of the software online help.

5. CHECK THE CLOCK SETTING

Select the item " *Setting of date and time* " of HD35AP-S software and make sure that the clock of the base unit is updated. If the clock is not updated, set it as explained in the chapter " *Clock setting* " of the software online help.

6. POWER THE OTHER NETWORK DEVICES

Open the housing of the other devices and connect the battery or the external power supply depending on the model.

- **Factory-configured system:** at startup, data loggers synchronize the clock with that of the base unit. If the base unit is not yet connected to the power supply, the synchronization fails and data loggers with LCD option display the clock setting window. Clock synchronization will anyway take place automatically after connecting the base unit to the power supply. Meanwhile, data loggers start storing measurements with their date and time, not synchronized with respect to the system measurements. If you wish to set the clock manually, see paragraph *The menu in LCD data loggers* on page 38.
- **Not configured system:** at startup, data loggers don't synchronize the clock with that of the base unit. In the data loggers with LCD, the window for the clock setting is displayed. Clock synchronization will take place automatically after network configuration (step 8), in the meantime data loggers start storing measurements with their date and time. If you wish to set the clock manually, see paragraph *The menu in LCD data loggers* on page 38.

7. ACTIVATING THE RF STAGE IN THE DEVICES (DATA LOGGERS, REPEATERS AND ALARM MODULES)

In the devices belonging to a factory-configured system, the RF stage is activated automatically. In this case, proceed to step 9.

If the system is not factory-configured, the RF stage of the devices will have to be activated manually by pressing the connection button for 5 seconds. In the indoor models, the connection button is on the front panel. In the outdoor models, the connection button is internal and is indicated with CONNECT / DISCONNECT on the electronic board.

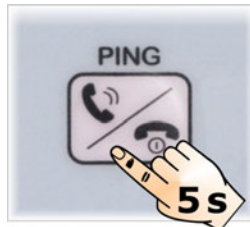

Fig. 3.3: connection button in models in indoor-use housing

The activation of the RF stage is signaled by the lightning-up of the green RF LED for one second and by a beep of the buzzer. Successively, the red RF LED will start blinking until the device is added to a wireless network following the procedure indicated at step 8.

In data loggers with LCD, the activation of the RF stage is signaled also by the connection icon. The icon will go on blinking until the device is added to a wireless network.

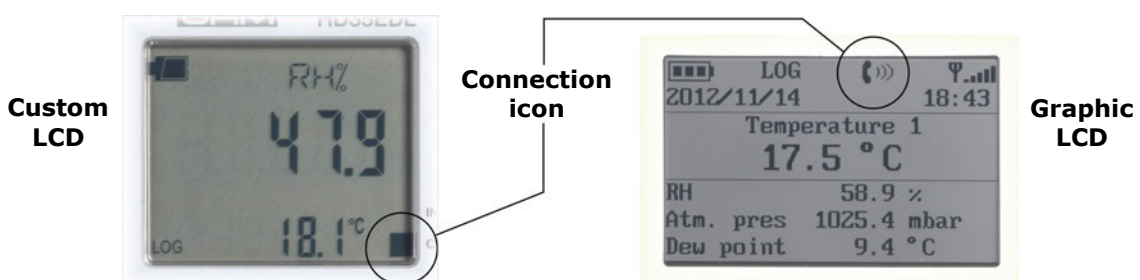

Fig. 3.4: connection icon on display

In case of doubt of the RF stage status in the devices without LCD (for example, because LEDs seldom blink due to a long logging interval), press the connection button for 5 seconds. If the green RF LED lights up, the RF stage was not active and will be activated. If the red RF LED lights up, the RF stage was already active and will be deactivated; in that case, press again the connection button for 5 seconds to reactivate it.

8. ADDING THE DEVICES TO THE NETWORK

If the network structure is not configured, it is necessary to add data loggers and any repeaters and alarm modules to the base unit. The adding procedure, described in detail in the chapter " *Adding devices to the network* " in the software online help, is briefly outlined hereunder:

1. Select the command " *Network* " of HD35AP-S software.
2. In the section " *Add Devices* " of the window " *Network* ", select the button " *Execute search* ".
3. At the end of the search, the software will list the devices available to be added to the network; select the devices, identified by the RF address, and enter the serial number of each device (RF address and serial number are written on the label on the rear of the instrument).
4. Select the button " *Add to network* ".

Note: the procedure for adding the devices to the network allows a limited number of devices to be added at a time. If the software doesn't list all the devices to be added, complete in any case the procedure with the listed devices and repeat the procedure to add the missing devices. By repeating the procedure, the software will list only the devices that have not been added yet.

Note: during the procedure, keep a distance of at least 2 meters between devices and base unit, in order to avoid RF signal saturation.

The maximum number of devices that can be added to a base unit depends on the data transmission interval, as indicated in the following table.

TAB. 3.1: Number of devices manageable by the base unit

Data transmission interval	Number of devices manageable by base unit	Data transmission interval	Number of devices manageable by base unit
1 s	12	10 s	120
2 s	24	15 s	180
5 s	60	> 30 s	254

The table refers to the condition of direct transmission between base unit and data loggers (1 "Hop") in HD35...**E** (868 MHz) and HD35...**U** (902-928 MHz) systems. In the presence of repeaters, the data transmission requires more time, and the number of devices manageable by the base unit could be lower than the one indicated.

9. CHECKING THE QUALITY OF RF COMMUNICATION

The correct RF communication between base unit and the other devices connected to the network can be checked in the following ways:

- In the main window of the HD35AP-S software, by checking that the RF signal level remains high, that the strength of the received signal RSSI (Received Signal Strength Indication) exceeds -85 dBm and that the percentage of transmission errors PER (Packet Error Rate) is close to zero.

Model	SN	Connection status	Signal level img	Reception power	PER mac
ED_76	HD35EDL1N4r2TV 12039377	CONN	[Signal level bar]	-36 (dBm) 00,0 (%)	
ED_107	HD35EDL1NTC 13022851	CONN	[Signal level bar]	-61 (dBm) 00,0 (%)	
ED_92	HD35EDL1NTV 11011875	CONN	[Signal level bar]	-54 (dBm) 00,0 (%)	

Fig. 3.5: verification of RF communication with HD35AP-S software

- In data loggers with LCD, by checking that the strength of the received signal RSSI exceeds -85 dBm and that the percentage of transmission errors PER is close to zero. Use the button ▲ to display RF RSSI and PER quantities.
- In the devices without display, by briefly pressing the connection button (PING function) and by making sure that the green RF LED blinks for a few seconds;

10. INSTALLING THE DEVICES

After a bench test of the system, proceed with the individual installation of the devices in the final work location.

11. CHECKING WHETHER THE DEVICES ARE REACHABLE

After installing the devices, you need to verify again the correct RF communication between the base unit and the other devices of the network, in order to make sure you didn't place the devices too far from the base unit or in places that make RF transmission difficult (shielded environments or with several obstacles). To check RF communication, proceed as indicated at step 9.

12. ADDING REPEATERS TO THE NETWORK

If a device is not reachable after installation (it fails communication with the base unit), it could be necessary to install one or more repeaters in intermediate points between the device and the base unit.

To add a repeater to the network, connect the internal battery to the repeater and repeat the installation procedure from step 7 only for the repeater.

13. CONFIGURING NETWORK PARAMETERS

Through the HD35AP-S software, set all the system operation parameters: logging intervals, alarm thresholds, user codes, etc.

For data loggers, specify whether they are installed in a stationary location or mobile location (for ex. in an articulated vehicle).

See software instructions for the setting of the various parameters.

CHANGING THE RF BAND IN THE ...U MODELS

The ...U models can operate in the 902-928 (U.S.A. and Canada), 915-928 (Australia) or 921.5-928 (New Zealand) MHz frequency band. To change the band in the devices with LCD, select the *RF Frequency* item of the *RF Parameters* menu (models with graphic LCD) or the *RF_FREQ_MHZ* item of the *RF_MENU* menu (models with custom LCD). To change the band in the devices without LCD, proceed as follows:

- 1) If the device is equipped with mini-USB connector on the housing side, connect it to the PC by means of the **CP31** cable.
- 2) Start the HD35AP-S software and select the *Tools >> HID terminal* command.
- 3) Select *Setup >> Uart configuration*.
- 4) Set the Baud Rate to 9600 for the ...ED devices. Set the Baud Rate to 115200 for the ...RE and ...AP devices. Press *Apply*.
- 5) Select *Connect*.
- 6) Transmit the command **<000>PW;nnnn** with *nnnn*=administrator password.
- 7) Transmit the command **<000>MC;n** with *n*=1 for the 902-928 MHz band, *n*=2 for the 915-928 MHz band and *n*=5 for the 921.5-928 MHz band.
- 8) Select *Disconnect*.

Note: after the transmission of a command, check that in the reply of the device appears the confirmation symbol **&**.

4 NETWORK MODIFICATION

One or more devices can be added or removed to/from the network at any time.

ADDING A DEVICE TO AN ALREADY OPERATING NETWORK

To add a device to the network, connect the internal battery to the device and repeat the installation procedure from step 7 concerning only the device to be added.

REMOVING A DEVICE FROM AN ALREADY OPERATING NETWORK

To remove a device from the network, follow the procedure indicated in detail in the chapter "*Removing devices from the network*" of the software online help, and briefly described here-under:

1. Select the command "*Network*" of the HD35AP-S software.
2. In the section "*Delete Devices*" of the window "*Network*", select the device that you wish to remove from the network.
3. Select the button "*Delete Devices*".

The removal procedure of a device from the network allows to select whether to turn-off the device RF circuit after disconnection or to keep it turned-on so as to allow any connection to another network. If the RF circuit is kept turned-on, it turns-off after 30 minutes if in the meantime the device is not connected to another network.

5 FIXING THE HOUSING

The installation of the indoor models is on the wall using the removable support provided or, alternatively, using the optional HD35.11K kit for fixed installation with safety lock.

The outdoor models can be wall mounted using the holes on the back of the housing (accessible by opening the housing) or the HD35.24W optional flange or installed on a \varnothing 40...50 mm mast using the HD35.24C optional flange. The models supplied with solar shield are already prepared for fixing to a mast.

If the data logger requires external probes, connect them to the inputs at the bottom of the instrument. If the data logger has several inputs, respect the indications reported near the inputs (type of probe, channel number, polarity for differential pressure).

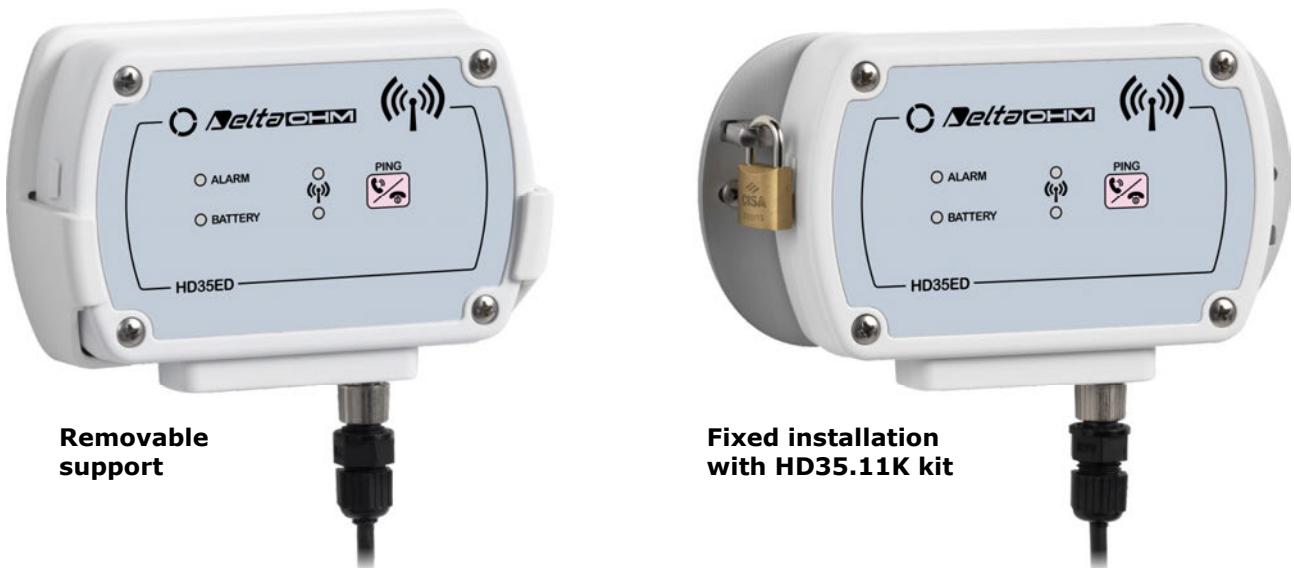

Fig. 5.1: indoor models installation modes

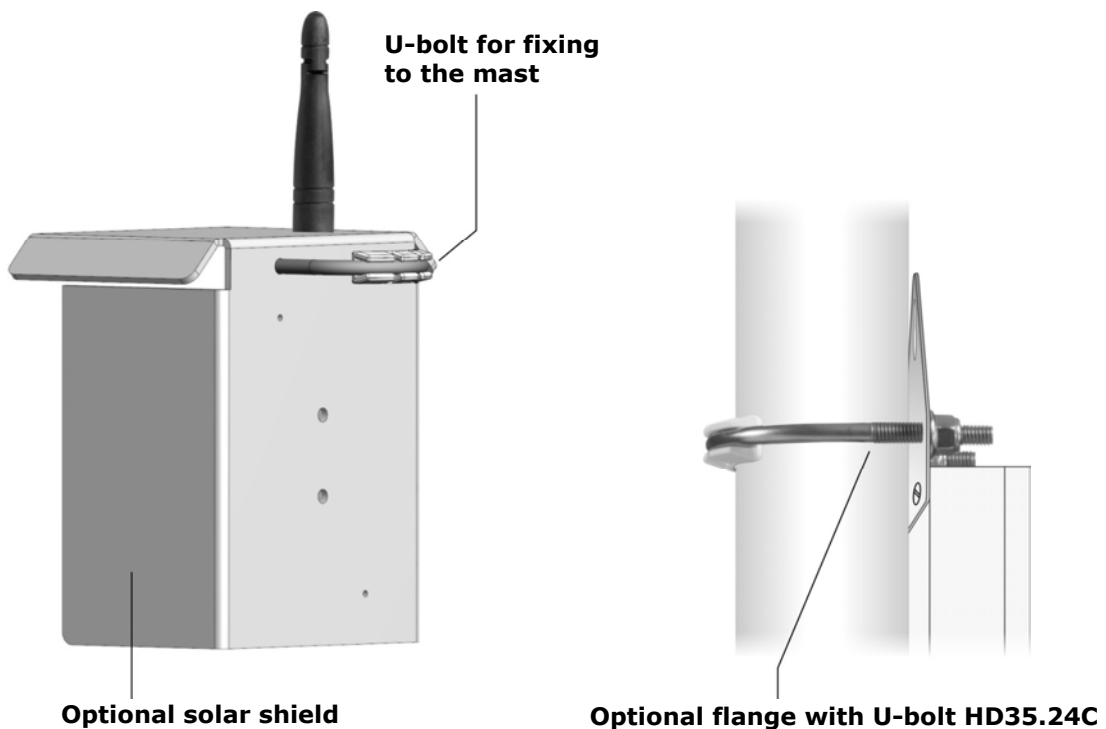

Fig. 5.2: outdoor models mast installation modes

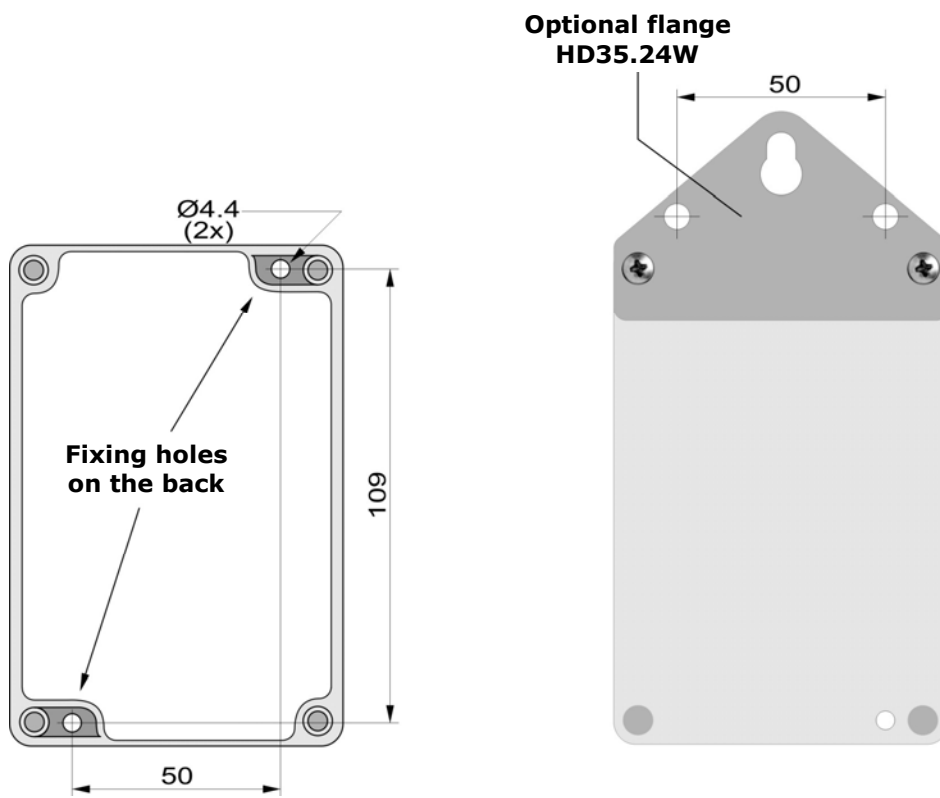
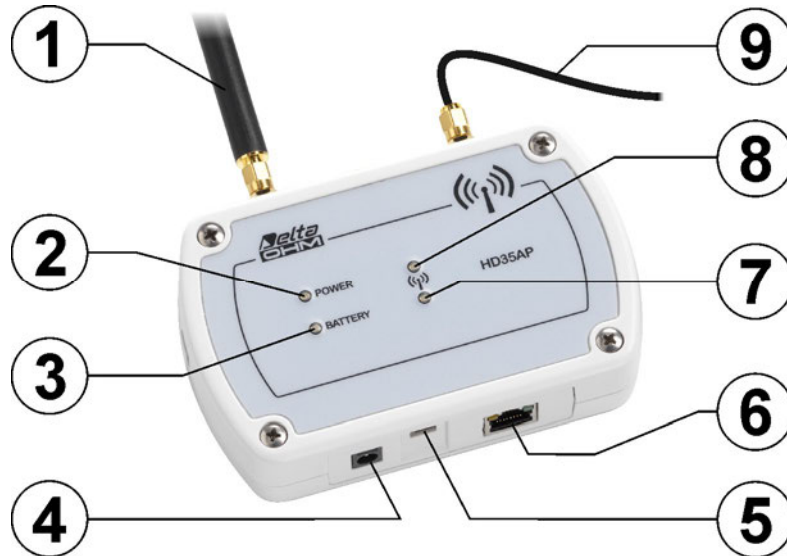

Fig. 5.3: outdoor models wall mount installation modes

6 BASE UNITS HD35AP...

6.1 DESCRIPTION OF VERSIONS FOR INDOOR USE



1. RF antenna for transmission in ISM band. In the HD35APW and HD35APxG models the antenna is on the left. In the HD35APS model, the antenna is in the center.
2. POWER LED: in red color, it indicates the presence of an external power supply; it blinks if the battery is recharging.
3. BATTERY LED: in green color, it indicates the internal battery charge level. When the indicator light is steady on, the battery is fully charged; as the battery is running low, the LED blinks with a lower and lower frequency (the blink period increases of 1 second for each 10% decrease of the battery charge).
4. Connector for external 6 Vdc power supply (**SWD06**).
5. Mini-USB connector for PC connection. The PC USB port powers the instrument in the absence of an external power supply.
6. Connector present only in **HD35APW** and **HD35APS** models. In HD35APW models, the connector is a RJ45 type for connection to the ETHERNET network. In HD35APS models, the connector is an 8-pole M12 type for connection to the RS485 network.
7. Green RF LED: it blinks when the unit is in normal operation mode.
8. Red RF LED: it blinks to signal problems in RF transmission.
9. Cellular antenna cable (only **HD35APxG**). Place the antenna at least 30 cm away from the RF antenna.

6.2 DESCRIPTION OF HD35APR DIN RAIL VERSION

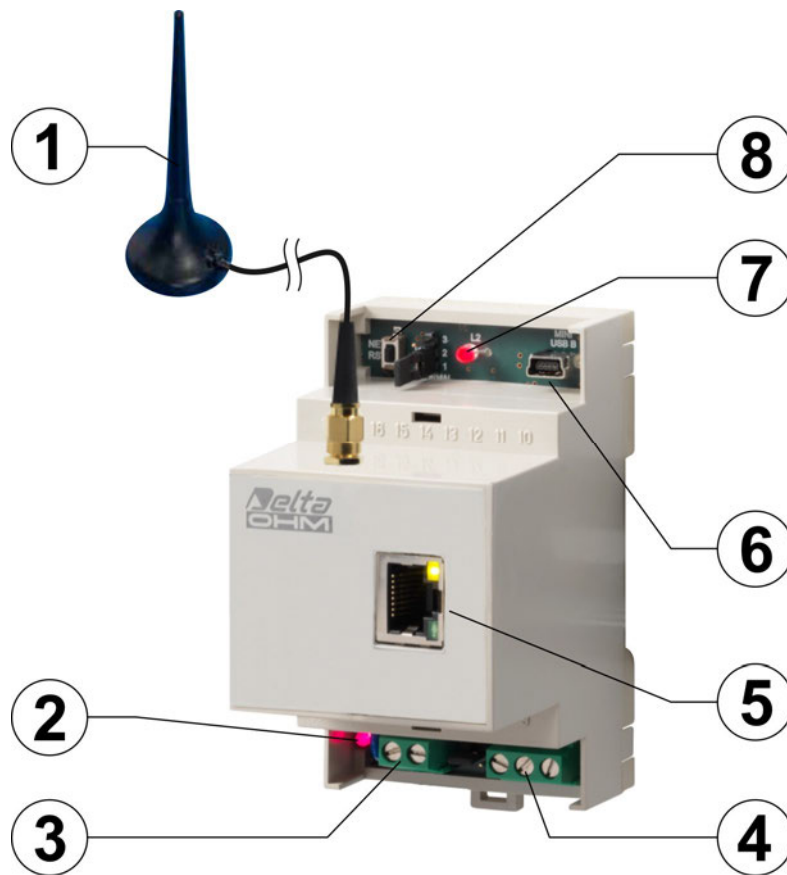

1. RF antenna for transmission in ISM band.
2. POWER LED: in red color, it indicates the presence of an external power supply.
3. Connector for external 8...30 Vdc power supply.
4. RS485 (Modbus-RTU protocol) connector.
5. ETHERNET RJ45 connector.
6. Mini-USB connector for PC connection. The PC USB port powers the instrument in the absence of an external power supply.
7. Bicolor RF LED: it blinks green when the unit is in normal operation mode; it blinks red to signal problems in RF transmission.
8. Button and jumper for restoring the default ETHERNET settings.

6.3 DESCRIPTION OF HD35APxGMT VERSIONS FOR OUTDOOR USE

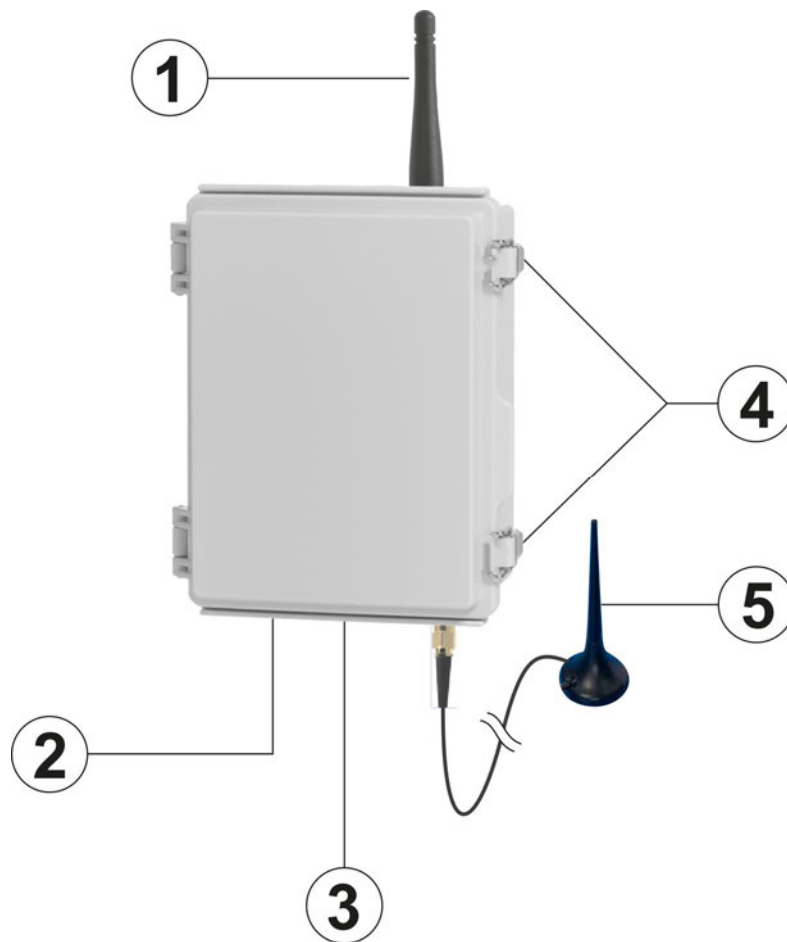

1. RF antenna for transmission in ISM band.
2. Input for external power supply.
3. Mini-USB connector for PC connection.
4. Housing closing hooks.
5. Cellular antenna. Place the antenna at least 30 cm away from the RF antenna.

6.4 RF LEDs SIGNALS

GREEN LED	RED LED	DESCRIPTION
ON	ON	Initialization after a reset or battery connection.
Short blink every 3 s	OFF	Normal operation mode.
Short blink every 3 s	Short blink every 3 s	RF alarm: at least one device exceeded the set PER threshold (Packet Error Rate).
Blinking 1 s ON / 1 s OFF		The unit is changing RF channel.
Blinking 1 s ON / 1 s OFF	Blinking 1 s ON / 1 s OFF	The unit is changing RF channel and signaling an RF alarm (alarm signaling is normal during an RF channel change).
OFF	Blinking 1 s ON / 4 s OFF	Date/time not set. It is necessary to set the clock.
OFF	Blinking 1 s ON / 2 s OFF	There is an error in the user configuration parameters.
OFF	Blinking 1 s ON / 1 s OFF	There is an error in the factory configuration parameters or a hardware component is not working properly.
OFF	OFF	Firmware upload or network file transfer. The RF activity is suspended until upload completion.

6.5 AVAILABLE CONNECTIONS DEPENDING ON MODEL

All units have a USB connection. The following table shows the additional connections in the various models.

	HD35APD	HD35APS	HD35APxG[MT]	HD35APR	HD35APW
RS485		✓		✓	
Wi-Fi					✓
Ethernet				✓	✓
Cellular⁽¹⁾			✓		
TCP/IP proprietary protocol			✓	✓	✓
Modbus RTU protocol⁽²⁾		✓		✓	
Modbus TCP/IP protocol⁽²⁾				✓	✓
Data via e-mail			✓	✓	✓
Data via FTP			✓	✓	✓
Data via HTTP (Cloud)			✓	✓	✓
SMS (only alarms)			✓		

⁽¹⁾ The type of cellular connection depends on model: **2G** in HD35APG..., **3G/2G** in HD35AP3G..., **4G/3G/2G** in HD35AP4G...

⁽²⁾ For the registers, see the document "**HD35 series Modbus protocol**" downloadable from the Delta OHM website.

6.6 USB CONNECTION

The base units can be connected to a PC through the mini-USB connector and **CP31** cable (directly with type A USB connector for HD35APD). In this connection mode, the base unit is powered through the PC USB port.

USB connection doesn't require the installation of drivers: when the base unit is connected to a PC, Windows® operating system automatically recognizes the unit as an HID device (Human Interface Device) and uses the drivers already included in the operating system.

Note: if the external power supply is not used but only the USB connection, it is recommended to connect the unit to a minimum 500 mA USB port to allow a sufficient recharging of the internal battery (only for models with internal battery).

6.7 ETHERNET OR WI-FI CONNECTION

The **HD35APW** base unit can be connected to a PC through an Ethernet or Wi-Fi local network. The choice of the connection mode, Ethernet or Wi-Fi, and of the relevant settings must be performed with the HD35AP-S software. The **HD35APR** base unit can be connected to a PC through an Ethernet local network

In the connection mode through local network, the **HD35APW** base unit must be powered by means of the **SWD06** external power supply.

For the Ethernet mode, connect the RJ45 connector of the base unit to a local network socket by means of a standard Ethernet cable.

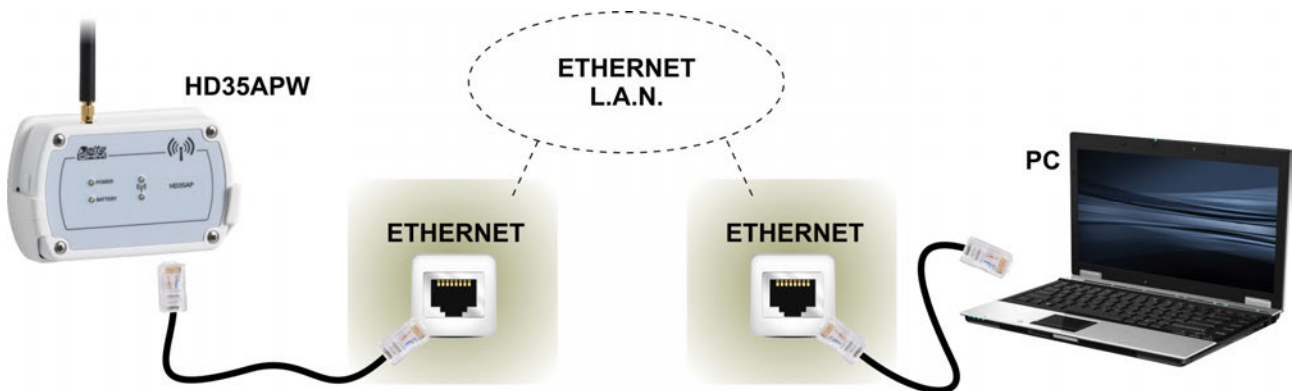

Fig. 6.5.1: ETHERNET connection

In Wi-Fi mode, connect the base unit to an available Wi-Fi network using the HD35AP-S software (see software instructions).

The base unit connects to the router of the local network (Wi-Fi Access Point, in Wi-Fi mode) and works as a **client**-type device. It is possible to set a fixed (static) IP address or configure the DHCP mode (Dynamic Host Configuration Protocol) so as the unit requests a dynamic IP address to the network server/router.

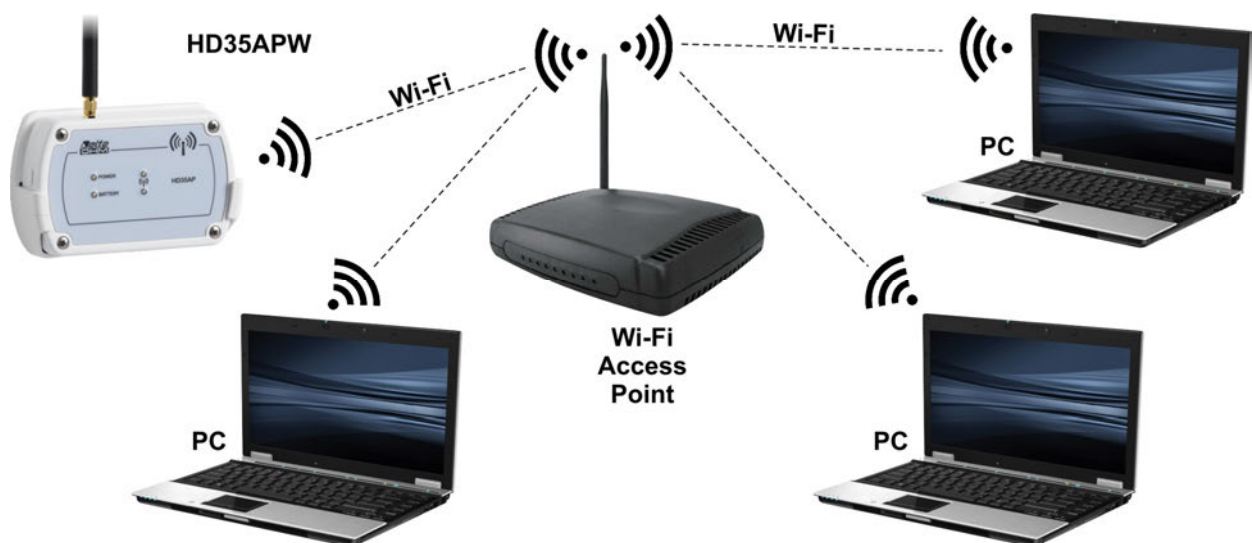

Fig. 6.5.2: base unit in Wi-Fi mode operating as a client

It is possible to access the base unit from any PC of the local network where the basic HD35AP-S software was installed (see the connection procedure presented in chapter " *Connection to base unit* " of the software online help).

The connection to the base unit is **multi-client**: the unit has two TCP/IP virtual ports and ten sockets in total to be divided between the two ports. Each port can operate with TCP/IP or MODBUS TCP/IP protocol. The ports setting (port number, number of socket assigned and type of protocol) must be performed with the HD35AP-S software (see software instructions). In MODBUS TCP/IP mode, the base unit works as "Modbus TCP/IP gateway".

6.8 RS485 CONNECTION

The **HD35APR** and **HD35APS** base units have a RS485 communication port with **MODBUS-RTU** protocol. For connecting the **HD35APS** base unit, use the CPM12-8D... series cables with 8-pole M12 connector. The figure and the table below show the numbering and the function of the connector contacts:

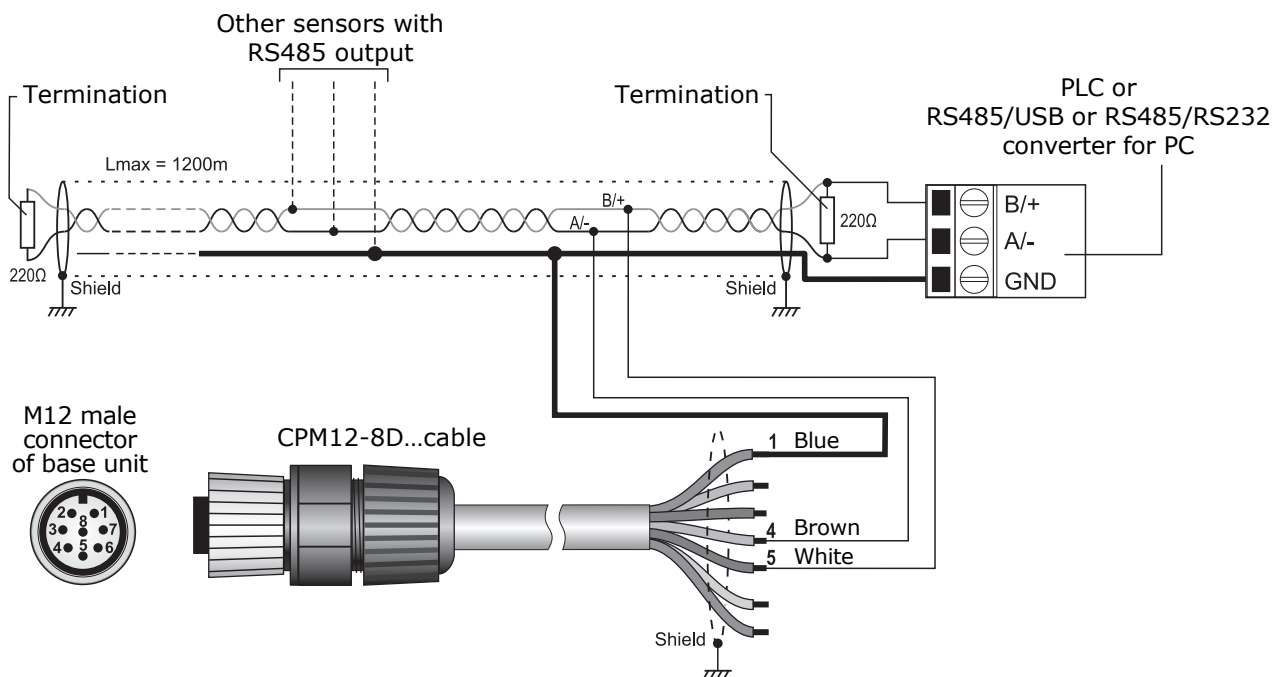

Fig. 6.6.1: RS485 connection

TAB. 6.6.1: CPM12-8D... cable

Connector	Function	Color B
1	GND	Blue
2	Not used	Red
3	Not connected	
4	RS485 A/-	Brown
5	RS485 B/+	White
6	Shield	Black
7	Not connected	
8	Not connected	

Thanks to RS485 connection, several instruments can be connected in a multi-point network. The instruments are connected in sequence by means of a shielded cable with twisted pair wires for signals and a third wire for the ground.

Line terminations must be placed at the ends of the network. The cable shield must be connected to both ends of the line.

The maximum number of devices that can be connected to the line (Bus) RS485 depends on the

load characteristics of the devices to be connected. The RS485 standard requires that the total load doesn't exceed 32 (Unit Loads). The load of a base unit HD35APR or HD35APS is equal to 1 unit load. If the total load is higher than 32 unit loads, divide the network in segments and add a signal repeater between a segment and the following. A line termination must be placed at both ends of each segment.

The cable maximum length depends on the transmission speed and on the cable characteristics. Typically, the maximum length is 1200 m. The data line must be kept separated from any power lines to avoid interferences to the transmitted signal.

Each instrument in the network is univocally identified by an address ranging within 1 and 247. **There must be no more transmitters with the same address in the network.**

Before connecting the base unit to the RS485 network, configure address and Baud Rate (see chapter "*HD35AP... base unit configuration*" of the software *online help*). The communication parameters in the PC/PLC must be the same as those set in the base unit.

6.9 HD35APR CONNECTIONS

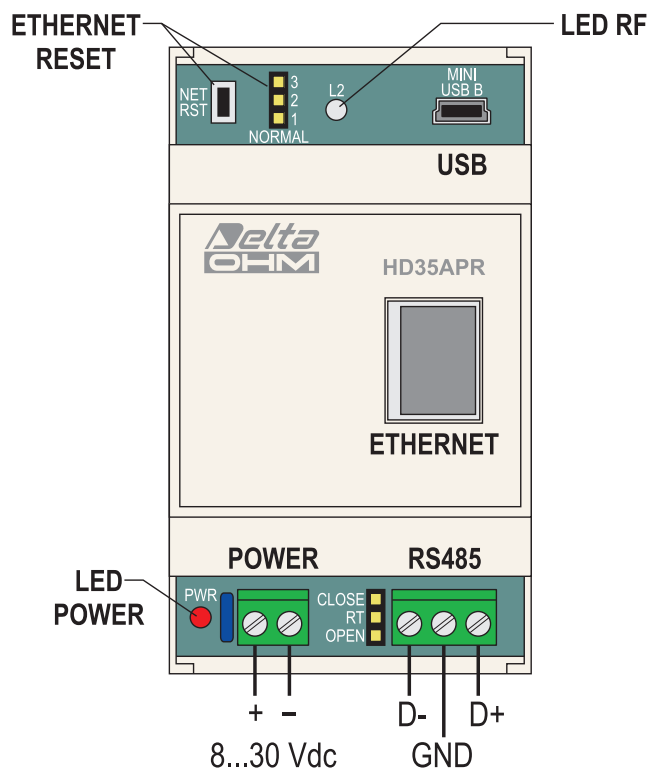

Fig. 6.7.1: HD35APR connections

RS485 line termination:

If the instrument is at one end of the RS485 line, insert the termination by placing the short jumper next to the RS485 connector between the "RT" and "CLOSE" indications. Otherwise, remove the termination by placing the short jumper between the "RT" and "OPEN" indications.

Factory ETHERNET settings:

- IP address = 192.168.1.235 static
- Subnet mask = 255.255.255.0
- Ports = 5100 for proprietary TCP protocol (8 sockets), 502 for Modbus TCP/IP protocol (2 sockets)

The ETHERNET settings can be changed with the HD35AP-S software. It is possible to restore the factory parameters by placing the short jumper next to the NET RST push-button between the "2" and "3" indications and then pressing the NET RST push-button. After the reset, replace the short jumper between the "2" and "1 (NORMAL)" indications.

6.10 HD35APxGMT POWER SUPPLY

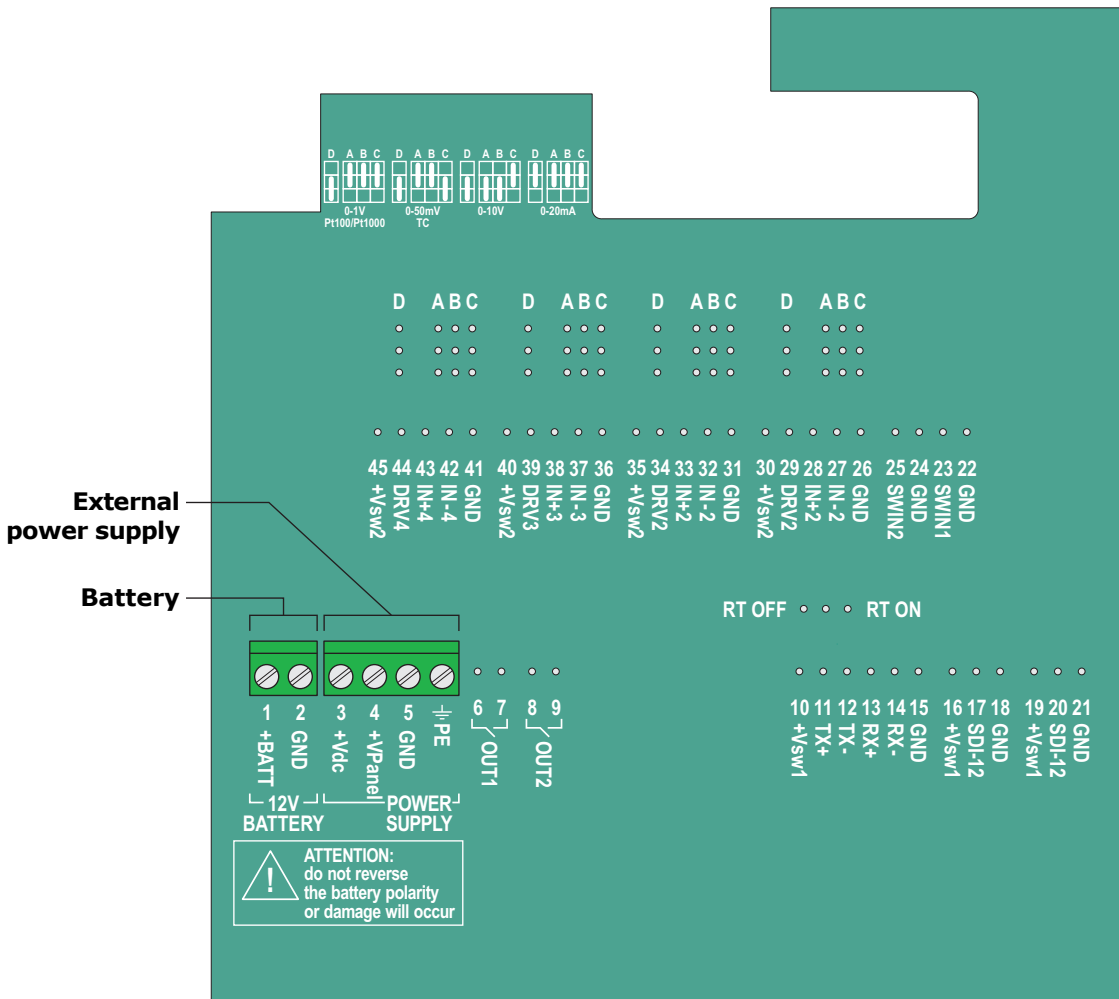

Fig. 6.8.1: HD35APxGMT power supply

In order to power the device with a solar panel, connect the panel to the +VPanel and GND terminals.

In order to power the device with a direct voltage power supply unit, (for example HD32MT.SWD), connect the power supply unit to the +Vdc and GND terminals.

ATTENTION: connect the PE terminal to ground through the cable gland at the bottom of the housing.

If a direct voltage power supply unit is used and the device is equipped with a rechargeable lead battery, the battery can be charged by shorting the +Vdc and +Vpanel terminals (provided that +Vdc is within the range 18...27 Vdc).

6.11 4G/3G/GSM CONNECTION

In order to use the GSM/3G functionalities of the base units equipped with 4G/3G/GSM module, a **SIM** card enabled for data transmission must be inserted into the unit. The card should be requested to a carrier that has an adequate coverage of the GSM/3G network in the place where the base unit will be installed.

Through the HD35AP-S software, set the necessary information for 4G/3G/GSM operation: SIM PIN, name of the APN access point, e-mail account and addresses, FTP address, telephone numbers, data transmission mode, etc. (see chapter " *GSM Options*" of the software online help).

In order to use the 4G/3G/GSM functionalities, the units HD35APxG must be powered by means of the **SWD06** external power supply.

Inserting the SIM card in the HD35APxGMT units (except HD35APG)

1. Disconnect the power supply.
2. Open the housing.
3. Push the metal block of the SIM tray in the direction of the arrow OPEN, and rotate the tray upward.
4. Insert the SIM card into its tray so as the SIM card contacts face down and correspond to the contacts on the electronic board. The SIM has to be inserted between the metal block and the plastic part.

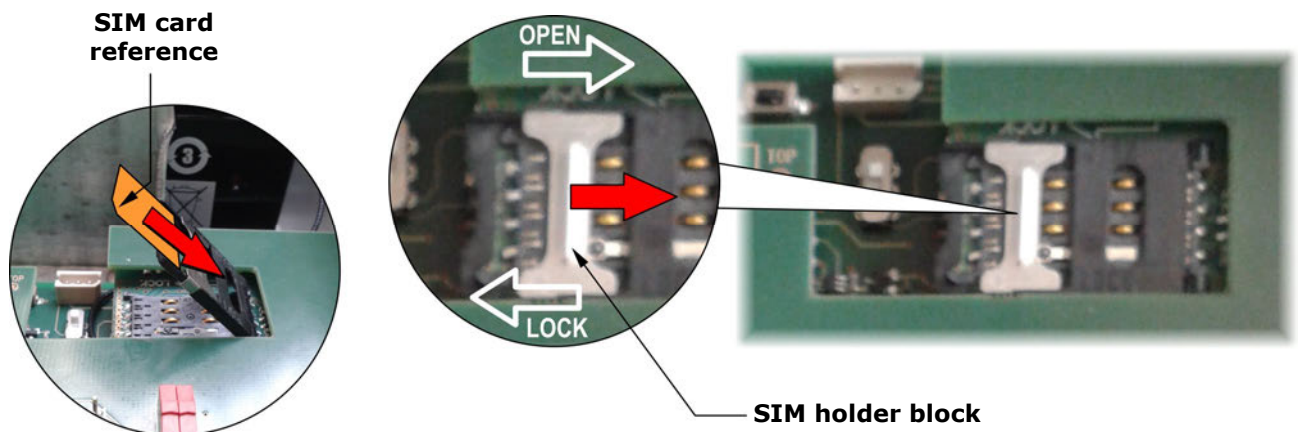

Fig. 6.9.1: inserting the SIM card

5. Put the SIM tray back in place and push the metal block in the direction of the arrow LOCK.
6. Reconnect the power supply and close the housing.

Note: do not change the position of the switch near the SIM card (it is used for updating the firmware of the 4G/3G/GSM module, together with the PWRKEY button).

Inserting the SIM card in the HD35APG units

1. Unscrew the 4 front screws on the housing and remove the back cover.
2. Disconnect the battery.
3. Press the release button of the SIM tray and, keeping the button depressed, extract the tray by making it slide upward.

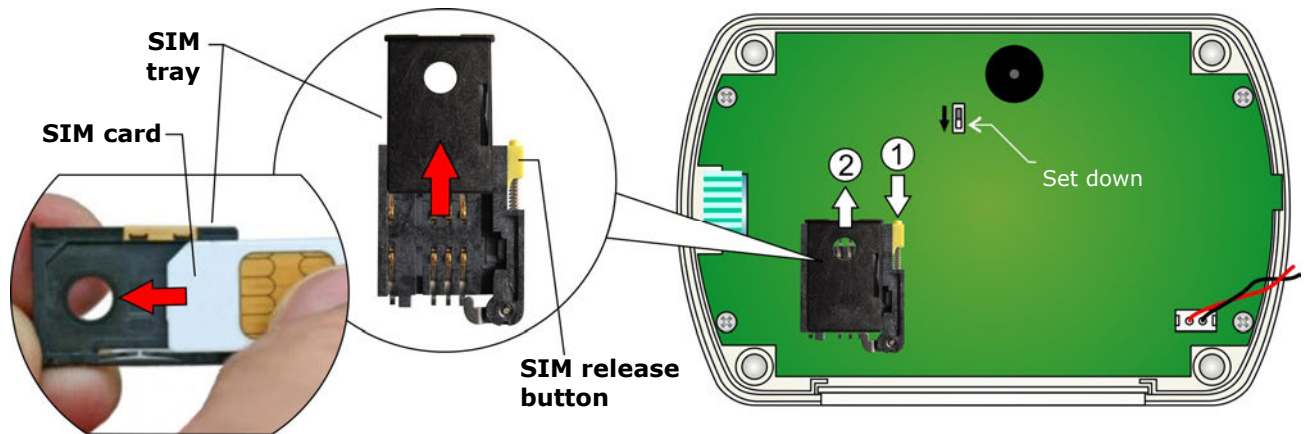

Fig. 6.9.2: inserting the SIM card

4. Insert the SIM card into its tray so as the SIM card contacts face the outside of the tray. The tray is provided with an insertion key that prevents the possibility of inserting the SIM card improperly.
5. Put the SIM tray back in place, making sure that the SIM card contacts face the instrument board.
6. Reconnect the battery.
7. Close again the housing by fixing the 4 front screws.

6.11.1 SENDING COMMANDS TO THE BASE UNIT FROM A MOBILE PHONE

SMS messages containing commands can be sent by a mobile phone to a base unit equipped with 4G/3G/GSM module, to change some 4G/3G/GSM settings of the unit. This feature is useful in case a connection to a PC with the base unit is not available.

The SMS must be sent to the number of the SIM card inserted into the base unit.

The following table lists the available commands.

TAB. 6.7.1: SMS commands

Command	Description
RESET	Reset of the base unit
EMAIL-ON	Activates periodic download of measurement data via e-mail
EMAIL-OFF	Deactivates periodic download of measurement data via e-mail
EMAIL-PERIOD= <i>period index</i>	Set the transmission interval via e-mail, where <i>period index</i> : 0->15 min, 1->30 min, 2->1 hour, 3->2 hours, 4->4 hours, 5->8 hours, 6->12 hours, 7->24 hours, 8->2 days, 9->4 days, 10->1 week
EMAIL-FORMAT= <i>format index</i>	Set the format of the data sent via e-mail, where <i>format index</i> : 1->log (format for database), 2->csv (format for Excel®), 3->log+csv
EMAIL-DL-START	Activates immediate data download by e-mail starting from the last measurement transmitted
EMAIL-DL-FROM=YYYY/MM/DD HH:MM:SS	Downloads data by e-mail starting from the specified date, where YYYY: year, MM: month, DD: day, HH: hour, MM: minutes, SS: seconds
EMAIL-DL-INTERVAL=YYYY/MM/DD HH:MM:SS - YYYY/MM/DD HH:MM:SS	Downloads by e-mail all data between the specified dates, where YYYY: year, MM: month, DD: day, HH: hour, MM: minutes, SS: seconds
EMAIL-ALARM-REPORT	Transmits by e-mail a report containing the current measurements of the selected devices for SMS/e-mail alarms
EMAIL-REPORT	Transmits by e-mail a report containing the current measurements of all the network devices

Command	Description
EMAIL-HELP	Transmits an e-mail containing a list of all SMS commands
FTP-ON	Activates the periodic download of measurement data via FTP
FTP-OFF	Deactivates the periodic download of measurement data via FTP
FTP-PERIOD= <i>period index</i>	Set the transmission interval via FTP, where <i>period index</i> : 0->15 min, 1->30 min, 2->1 hour, 3->2 hours, 4->4 hours, 5->8 hours, 6->12 hours, 7->24 hours, 8->2 days, 9->4 days, 10->1 week
FTP-FORMAT= <i>format index</i>	Set the format of the data sent via FTP, where <i>format index</i> : 1->log (format for database), 2->csv (format for Excel®), 3->log+csv
FTP-DL-START	Activates immediate data download by FTP starting from the last measurement transmitted
FTP-DL-FROM= YYYY/MM/DD HH:MM:SS	Downloads data via FTP starting from the specified date, where YYYY: year, MM: month, DD: day, HH: hour, MM: minutes, SS: seconds
FTP-DL-INTERVAL= YYYY/MM/DD HH:MM:SS - YYYY/MM/DD HH:MM:SS	Downloads by FTP all data between the specified dates, where YYYY: year, MM: month, DD: day, HH: hour, MM: minutes, SS: seconds
FTP-ALARM-REPORT	Transmits by FTP a report containing the current measurements of the selected devices for SMS/e-mail alarms
FTP-REPORT	Transmits by FTP a report containing the current measurements of all the network devices
FTP-HELP	Transmits by FTP a file containing a list of all SMS commands
SMS-ALARM-ON	Activates the transmission of alarm SMS for the overrun of the measurement thresholds for the selected devices
SMS-ALARM-OFF	Deactivates the transmission of alarm SMS for the overrun of the measurement thresholds for the selected devices
SMS-RF-ALARM-ON	Activates the transmission of alarm SMS for RF problems in the selected devices
SMS-RF-ALARM-OFF	Deactivates the transmission of alarm SMS for RF problems
EMAIL-ALARM-ON	Activates the transmission of e-mail alarms when the selected devices have measurements in alarm
EMAIL-ALARM-OFF	Deactivates the transmission of e-mail alarms for measurement alarms
EMAIL-RF-ALARM-ON	Activates the transmission of e-mail alarms when the selected devices have RF problems
EMAIL-RF-ALARM-OFF	Deactivates the transmission of e-mail alarms for RF problems
SMS-ALARM-REPORT	Transmits by SMS the list of the devices in alarm condition. Only the selected devices are taken into consideration for SMS alarms
SMS-DEVICE-ALARM-REPORT= RF <i>address</i>	Transmits via SMS a report of the measurements selected for SMS alarms, of the device with specified RF address
SMS-DEVICE-REPORT= <i>RF address</i>	Transmits via SMS a report of the measurements of the device with specified RF address
SMS-HELP	Transmits an SMS containing the list of all SMS commands
TCP-SERVER-ON	Activates a TCP connection with AP acting as a TCP server
TCP-SERVER-OFF	Deactivates the TCP connection with AP acting as a TCP server
TCP-CLIENT-ON	Activates a TCP connection with AP acting as a TCP client
TCP-CLIENT-OFF	Deactivate the TCP connection with AP acting as a TCP client
TCP-SERVER-ADDRESS= " <i>server address</i> "	Specifies the server address for TCP connection when AP acts as TCP client. The server-address string can be a domain or a IP address
TCP-SERVER-PORT= <i>port number</i>	Specifies the number of the TCP port used by the remote server to accept connections with AP when AP acts as TCP client
TCP-LISTEN-PORT= <i>port number</i>	Specifies the number of the TCP listening port used by AP when AP acts as TCP server
HTTP-ON	Activates the periodic upload of measurement data on the HTTP server

Command	Description
HTTP-OFF	Deactivates the periodic upload of measurement data on the HTTP server
HTTP-PERIOD= <i>period index</i>	Set the transmission interval via HTTP, where <i>period index</i> : -1⇒Real time, 0⇒15 min, 1⇒30 min, 2⇒1 hour, 3⇒2 hours, 4⇒4 hours, 5⇒8 hours, 6⇒12 hours, 7⇒24 hours, 8⇒2 days, 9⇒4 days, 10⇒1 week
HTTP-DL-START	Activates immediate data upload on the HTTP server starting from the last measurement transmitted
HTTP-DL-FROM= YYYY/MM/DD HH:MM:SS	Uploads data on the HTTP server starting from the specified date, where YYYY: year, MM: month, DD: day, HH: hour, MM: minutes, SS: seconds
HTTP-DL-INTERVAL= YYYY/MM/DD HH:MM:SS - YYYY/MM/DD HH:MM:SS	Uploads on the HTTP server all data between the specified dates, where YYYY: year, MM: month, DD: day, HH: hour, MM: minutes, SS: seconds
ADD-PHONE= " <i>phone number</i> "	Adds a phone number to the list of numbers considered for SMS alarms
CANC-PHONE	Delete my phone number and don't consider it any more for SMS alarms. The primary phone number cannot be deleted
ERASE-PHONE= <i>phone number index</i>	Deletes the phone number with specified index. This command is accepted only by the primary phone number

Up to 16 commands can be written in the same text message, separated by spaces or commas.

For safety, commands are executed only if they are coming from the cell numbers set in the HD35AP-S software and if the SMS text starts with a user-defined key word. The key word is set through the HD35AP-S software, going to the menu " *GSM options* " at the item " *SMS recipients* " and setting the field " *SMS keyword* " (see chapter " *GSM settings* " of the software online help).

Example: supposing you entered the string ">>>" in the *SMS keyword* field and you wish to activate periodic download via e-mail of the measured data with an interval of 1 hour, you will have to send the following text message:

>>> EMAIL-ON EMAIL-PERIOD=2

With the commands EMAIL-HELP, FTP-HELP and SMS-HELP you can ask the base unit to send respectively by e-mail, to an FTP address and through SMS the complete list of the available SMS commands. This function is useful especially if you don't have the manual at hand, or to obtain the updated command list following the base unit firmware updates.

6.11.24G/3G/GPRS TCP/IP CONNECTION

Through 4G/3G/GPRS TCP/IP protocol, it is possible to interact with a base unit equipped with cellular module from a remote PC with an Internet connection.

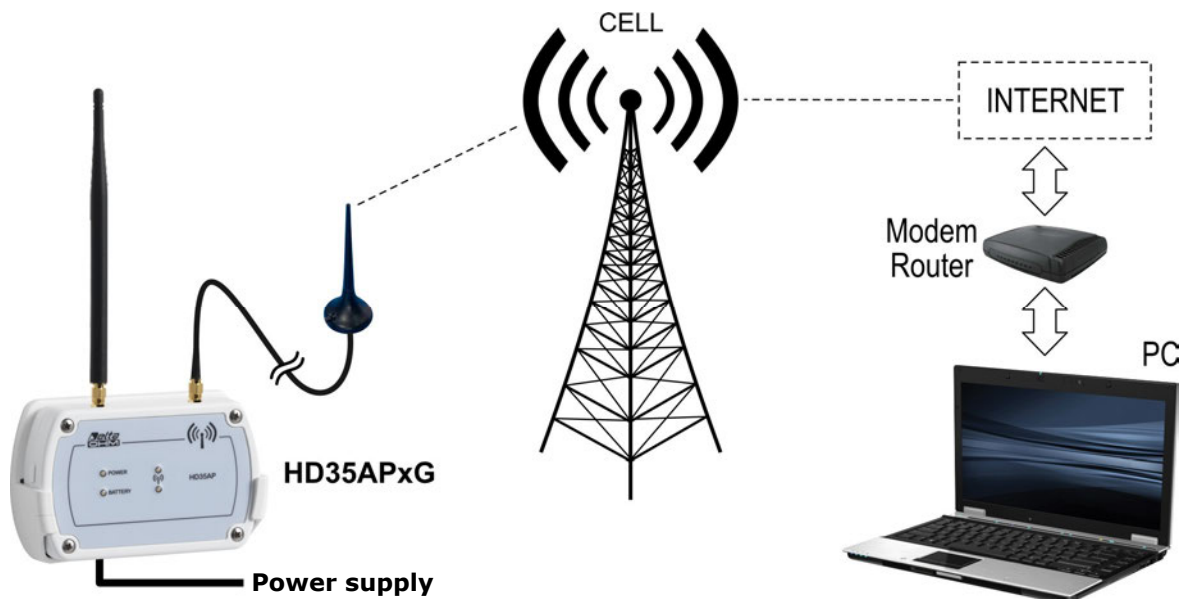

Fig. 6.9.3: 4G/3G/GPRS TCP/IP connection

The connection can be of two types:

1) **HD35APxG[MT] = Client , PC = Server**

HD35APxG[MT] acts as TCP client and requests the connection to the PC, the PC acts as TCP server and waits for the connection request. The server IP address (PC or Router) must be public and can be either static or dynamic; if the IP address is dynamic, it is convenient to register the server to a DDNS (Dynamic Domain Name System) service.

2) **HD35APxG[MT] = Server , PC = Client**

The PC acts as TCP client and requests the connection to HD35APxG[MT], HD35APxG[MT] acts as TCP server and waits for the connection request. The server IP address (HD35APxG[MT]) must be public and static.

Connection HD35APxG[MT] = Client , PC = Server

1. Open a port (port forwarding) in the Modem/Router through which your PC connects to Internet (follow the instructions of your Modem/Router).
2. Connect HD35APxG[MT] to a PC USB port and perform the connection procedure with the HD35AP-S software.
3. In the HD35AP-S software select *Instruments setup >> GSM options >> GPRS TCP/IP client settings* and set the server IP address or domain name and port number (number of the port opened in the Modem/Router).
4. Disconnect HD35AP...G from the USB port.
5. In the HD35AP-S software select *Tools >> Type of connection*, select the *TCP server* option and set the number of the port opened in the Modem/Router.
6. In the HD35AP-S software, select the *Connect* icon.
7. Send to HD35APxG[MT] the SMS command **TCP-CLIENT-ON**.

If the connection is not established within 30 minutes after sending the SMS command TCP-CLIENT-ON, the command must be sent again.

Alternatively, the server IP address or domain name and port number can be set in HD35APxG[MT] without connecting HD35APxG[MT] to the PC and without the HD35AP-S software by using the SMS commands **TCP-SERVER-ADDRESS** and **TCP-SERVER-PORT**.

Connection HD35APxG[MT] = Server , PC = Client

1. Open a listening port in HD35APxG[MT] by using the SMS command **TCP-LISTEN-PORT** (for example, TCP-LISTEN-PORT=2020).
2. Send to HD35APxG[MT] the SMS command **TCP-SERVER-ON**.
3. HD35APxG[MT] replies with a first SMS to confirm that the command has been accepted. Wait for a second SMS with the confirmation that the *TCP server* functionality has been activated and with the IP address (and port number) assigned to HD35APxG[MT].
4. In the HD35AP-S software select *Tools >> Type of connection*, select the *TCP client* option and set the IP address and port number of HD35AP...G.
5. In the HD35AP-S software, select the *Connect* icon.

If the connection is not established within 1 hour after sending the SMS command TCP-SERVER-ON, the command must be sent again.

6.12 BASE UNITS TECHNICAL SPECIFICATIONS

Transmission frequency	868 MHz, 902-928 MHz or 915.9-929.7 MHz according to the model Only HD35APD: 868 MHz or 902-928 MHz according to the model
Antenna	External whip antenna Only HD35APD: internal
Transmission range	In open field (it can decrease in the presence of obstacles or adverse weather conditions): 300 m (E, J)/ 180 m (U) towards data loggers with internal antenna > 500 m (E, J, U) towards repeaters and data loggers with external antenna Only HD35APD: 180 m (E, U) towards all data loggers
USB connection	Mini-USB connector (CP31 cable) in all models except HD35APD Only HD35APD: A type connector
RS485 connection	Only in HD35APS and HD35APR (MODBUS-RTU protocol)
Ethernet connection	Only in HD35APW and HD35APR
Wi-Fi connection	Only in HD35APW (frequency 2.4 GHz)
Cellular connection	GSM/GPRS: only in HD35APxG[MT] 3G: only in HD35AP3G[MT] and HD35AP4G[MT] 4G: only in HD35AP4G[MT]
Internal memory	The number of storable samples depends on the type of data loggers connected. The capacity is of 226,700 samples if all data loggers record 7 quantities.
LED indicators	Presence of external power supply (except HD35APD) Battery charge level (only models with lithium internal battery) RF communication status
Power supply	HD35APS, HD35APW and HD35APxG: Lithium-ion rechargeable battery (2250 mA/h, size 18650) Optional external 6 Vdc power supply (SWD06) Directly powered by a PC USB port (*) HD35APD: directly powered by the PC USB port HD35APR: external 8...30 Vdc (no internal battery) HD35APxGMT: external 18...27 Vdc (12 V lead-acid rechargeable internal battery, integrated battery charger)
Consumption	HD35APS, HD35APW and HD35APxG: ≈30 mA (E, U) / ≈38 mA (J) without Ethernet/Wi-Fi and with typical cellular activity (**), ≈180 mA with Ethernet, ≈150 mA with Wi-Fi HD35APR: 40 mA @ 24 Vdc HD35APxGMT: < 20 mA during measurement < 1 A peak during cellular activity
Lithium battery life (typical)	≈3 days (E, U) / > 2 days (J) if not connected to local network and with typical cellular activity (**), ≈12 hours with Ethernet, ≈14 hours with Wi-Fi
Operating temperature and humidity	-10...+60 °C / 0...85 %RH non-condensing (except HD35APxGMT) -40...+70 °C / 0...100 %UR (only HD35APxGMT)
Weight	HD35APS, HD35APW, HD35APxG and HD35APR: 200 g approx. HD35APxGMT: 1 kg approx.

Housing	HD35APS, HD35APW, HD35APxG and HD35APR: thermoplastic (see dimensional drawings, indoor use) HD35APxGMT: polycarbonate (270 x 170 x 110 mm, IP65 with protective cap on the USB connector)
Installation	HD35APS, HD35APW e HD35APxG: wall support (supplied) for removable installation or flanges (option) for fixed installation HD35APR: 35 mm DIN rail HD35APxGMT: fixing to a Ø 40...60 mm mast

(*) The connection of the SWD06 external power supply is necessary if the Ethernet, Wi-Fi or GSM/GPRS/3G transmission is used.

(**) The intensive use of the cellular communication can significantly increase the power consumption and reduce the battery life.

7 HD35RE... REPEATERS

7.1 DESCRIPTION OF HD35RE VERSION FOR INDOOR USE

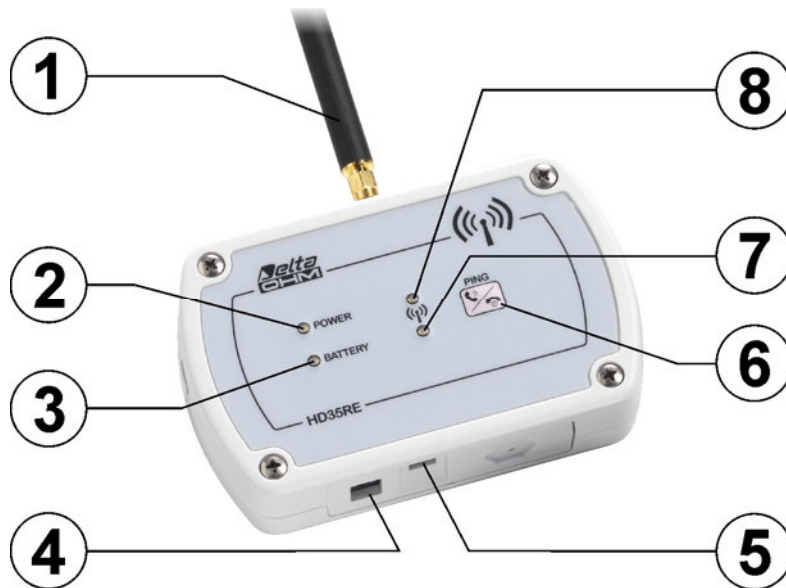

1. RF Antenna.
2. POWER LED: red color, it indicates the presence of the external power supply; it blinks if the battery is charging.
3. BATTERY LED: green color, it indicates the internal battery charge level. When the indicator light is steady on, the battery is fully charged; as the battery is running low, the LED blinks with a lower and lower frequency (the blink period increases of 1 second for each 10% decrease of the battery charge).
4. Connector for external 6 Vdc power supply (**SWD06**).
5. Mini-USB connector for PC connection. Use reserved for technical assistance.
6. Connection / PING (for testing RF) button.
7. Green RF LED: it blinks if the data transmission was successful.
8. Red RF LED: it blinks to signal that data transmission has failed.

The green and red RF LEDs blink simultaneously if the device is in error condition.

Power supply: since the repeater is normally not always connected to a computer, it is advisable to use an external power supply, since the internal battery life is of a few days.

7.2 DESCRIPTION OF HD35REW VERSION FOR OUTDOOR USE

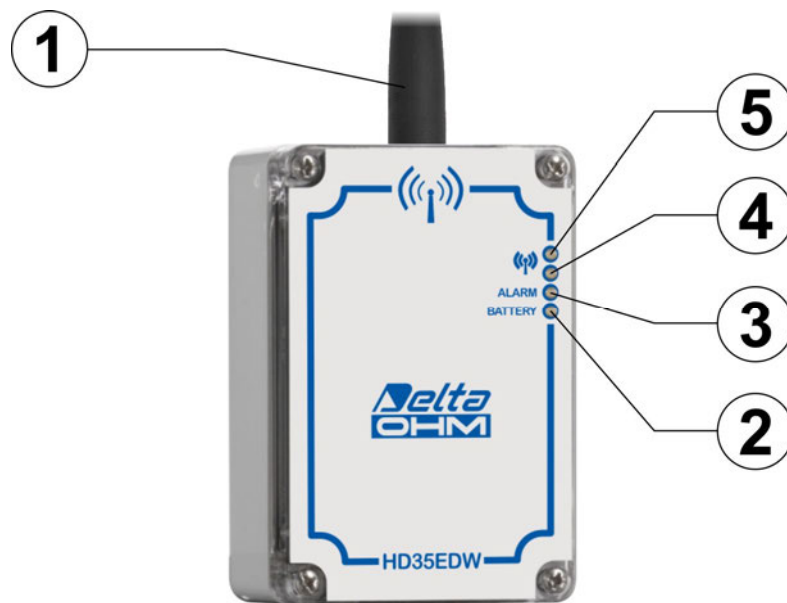

1. RF Antenna.
2. BATTERY LED: green color, it indicates the internal battery charge level. As the battery is running low, the LED blinks with a lower and lower frequency (the blink period increases of 1 second for each 10% decrease of the battery charge).
3. ALARM LED: not used.
4. Red RF LED: it blinks to signal that data transmission has failed.
5. Green RF LED: it blinks if the data transmission was successful.

The green and red RF LEDs blink simultaneously if the device is in error condition.

7.3 CONNECTION TO THE WIRELESS NETWORK

The device can be connected and disconnected to/from the wireless network by **pressing for 5 seconds**:

- the connection button on the front panel, for HD35RE (see point 6 of paragraph 7.1);
- the internal connection button, for HD35REW (see the following figure).

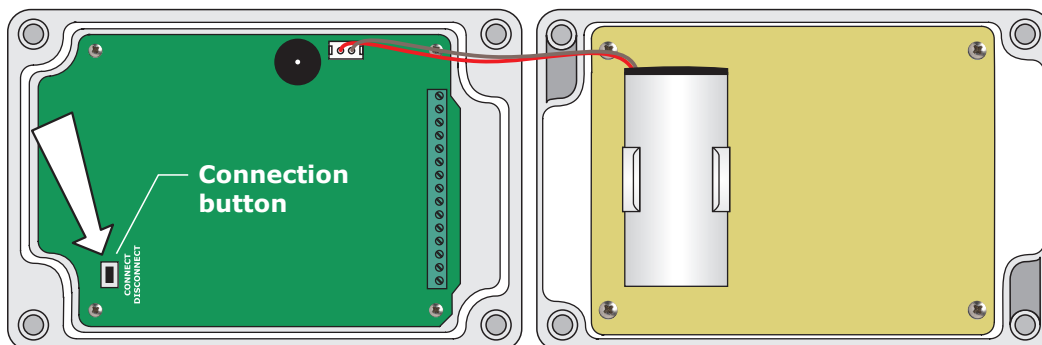

Fig. 7.4.1: HD35REW internal connection button

If the device is disconnected, by pressing the connection button for 5 seconds the buzzer emits a beep and the green LED activates for one second to indicate the start of the connection procedure. If the device belongs to a wireless network and the base unit is reachable, once connected, the buzzer emits a second beep and the green RF LED will blink during data transmis-

sion. If the device doesn't belong to a wireless network or the base unit cannot be reached, the second beep of the buzzer is not emitted and the red RF LED will blink.

If the device is connected, by pressing the connection button for 5 seconds the buzzer emits a beep, the red RF LED activates for one second and the device is disconnected.

PING function:

In the devices connected to a wireless network it is possible to check if the base unit can be reached by briefly pressing the connection button: if the green RF LED is blinking, it means that the base unit is reachable, otherwise it will be the red RF LED to blink.

7.4 ARRANGEMENT OF THE REPEATERS

Designing the system, it should be taken into account that between a HD35REW repeater and a HD35ED... data logger or between two HD35REW repeaters, only HD35REW repeaters can be interposed, as shown in following examples.

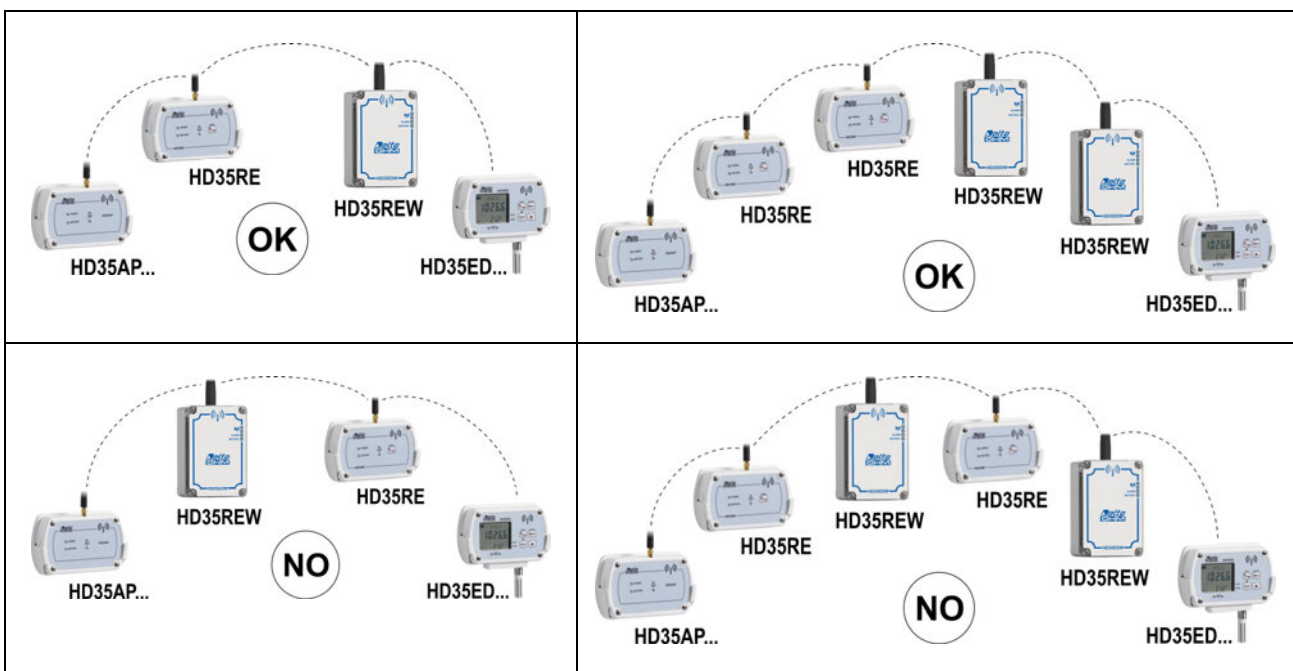

Fig. 7.5.1: arrangement of different types of repeaters

Unlike HD35RE repeaters, which have external power supply, the HD35REW repeaters are powered only by the internal battery. To extend the battery life, the RF stage of the HD35REW repeaters is not continuously active; therefore, the HD35REW repeaters are subject to the following restrictions:

- the alarm events may be reported with a certain delay;
- the adding of new devices to the wireless network must be done near the HD35AP.. base unit, without interposing HD35REW repeaters between the new devices and the base unit;
- the reconfiguration of the system may take longer; furthermore, if the configuration of a data logger with LCD is changed via the logger keyboard, the change is not notified to the base unit and to the HD35AP-S software;
- to guarantee the same transmission reliability of a system with HD35RE repeaters, HD35ED... devices may be obliged to transmit the same packets several times: this could affect battery life.

7.5 REPEATERS TECHNICAL SPECIFICATIONS

Transmission frequency	868 MHz, 902-928 MHz or 915.9-929.7 MHz according to the model
Antenna	External whip antenna
Transmission range	In open field (it can decrease in the presence of obstacles or adverse weather conditions): 300 m (E, J)/ 180 m (U) towards data loggers with internal antenna. > 500 m (E, J, U) towards base unit (except HD35APD), repeaters and data loggers with external antenna. 180 m (E, U) towards base unit HD35APD.
USB connection	Mini-USB connector (CP31 cable) In HD35REW the connector is internal Only for configuration and firmware update, not for data download
LED indicators	Presence of external power supply (only HD35RE), battery charge level, RF communication status
Push-buttons	Connection / PING (for testing RF) button In HD35REW the button is internal
Power supply	HD35RE: Lithium-ion rechargeable battery (2250 mA/h, size 18650) Optional external 6 Vdc power supply (SWD06) Directly powered by a PC USB port HD35REW: Li-SOCl ₂ non-rechargeable battery (8400 mA/h, size C)
Current consumption	Only HD35RE: ≈30 mA (E, U) / ≈38 mA (J)
Battery life	HD35RE: ≈3 days (E, U) / > 2 days (J) HD35REW: 2 years typical (repeating the signal of 5 data loggers transmitting every 30 s)
Operating temperature and humidity	HD35RE: -10...+60 °C / 0...85 %RH non-condensing HD35REW: -20...+70 °C / 0...100 %RH non-condensing
Weight	HD35RE: 200 g approx. HD35REW: 250 g approx.
Housing	HD35RE: thermoplastic HD35REW: polycarbonate, IP 67 See dimensional drawings
Installation	HD35RE: wall support (supplied) for removable installation or flanges (option) for fixed installation HD35REW: wall mount or fixing to a Ø 40 mm mast

8 HD35ED... DATA LOGGERS

8.1 DESCRIPTION

INDOOR MODELS

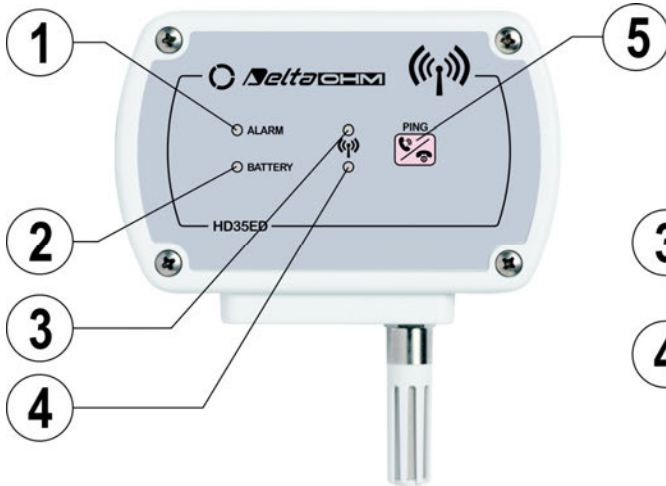

Models without display



Models with LCD display

OUTDOOR MODELS

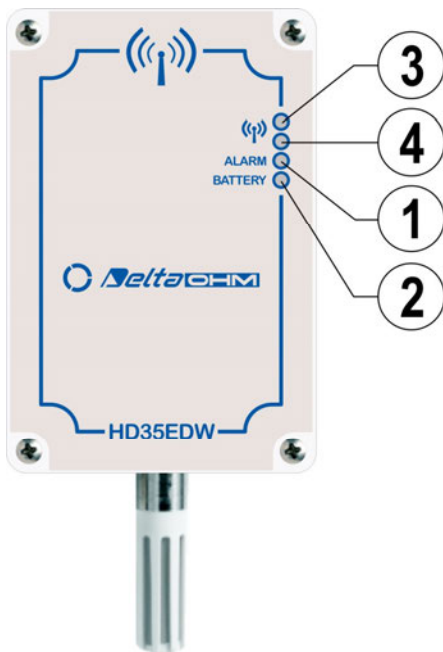

Models without display







Models with LCD display

1. ALARM LED: red color; it blinks when a measurement is in alarm condition.
2. BATTERY LED: green color, it indicates the internal battery charge level. As the battery is running low, the LED blinks with a lower frequency (once every 5 s = battery is charged, once every 10 s = 50% battery charge, once every 15 s = battery is almost discharged).
3. Red RF LED: it blinks to signal that data transmission has failed. It blinks simultaneously with the green RF LED if the device is in error condition.
4. Green RF LED: it blinks when the data transmission has been successful. It blinks simultaneously with the red RF LED if the device is in error condition.

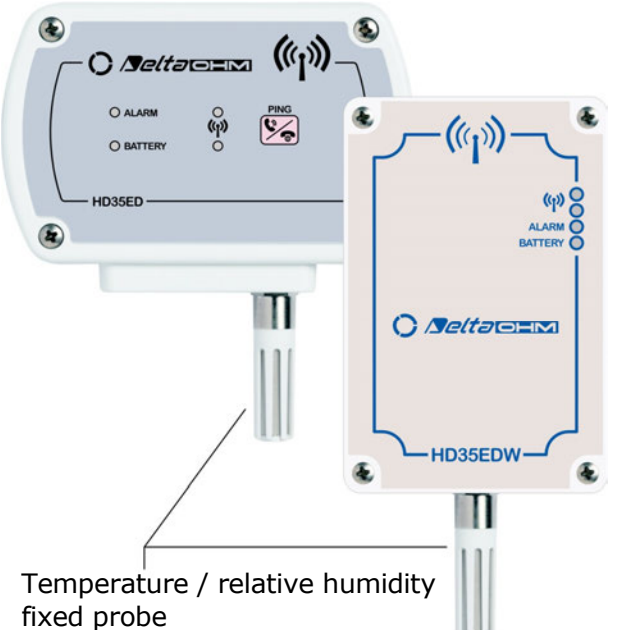
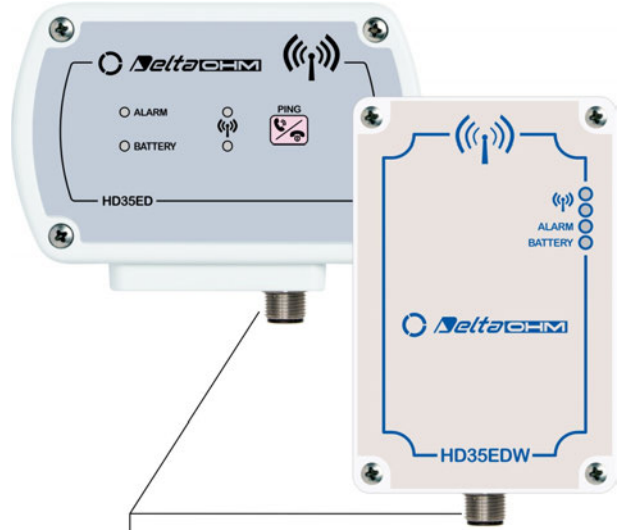
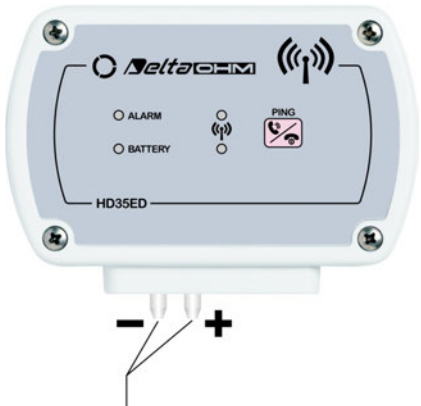
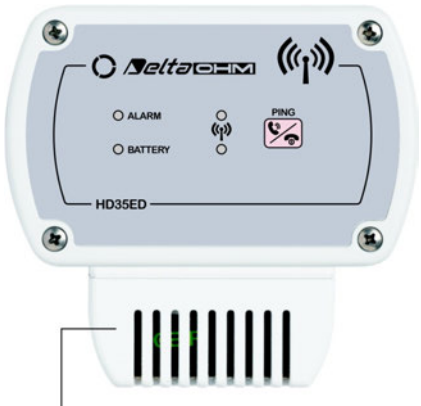
5. Connection / PING (for testing RF) button.
6. MENU/ENTER key: allows access to the configuration menu; confirm the selected option or the set value in the menu.
7. ▲ key: in normal operation, it scrolls the quantities measured by the data logger; it scrolls upwards the available options or increases the set value in the menu.
8. FUNC/▼ key: in normal operation, it displays the maximum (MAX), the minimum (MIN) and the average (AVG) of the measurements; it scrolls downwards the available options or decreases the set value in the menu.
9. LCD Display.
For the indoor models, the type of display, custom or graphic, depends on the model. For the outdoor models, the display is always custom.

TYPE OF SENSORS / CONNECTIONS

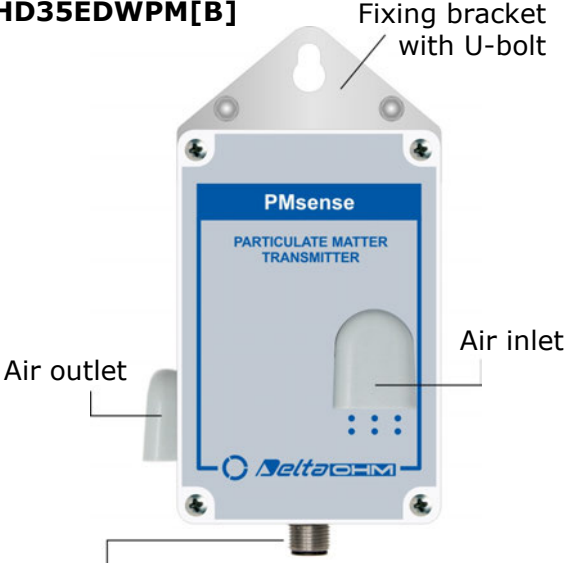
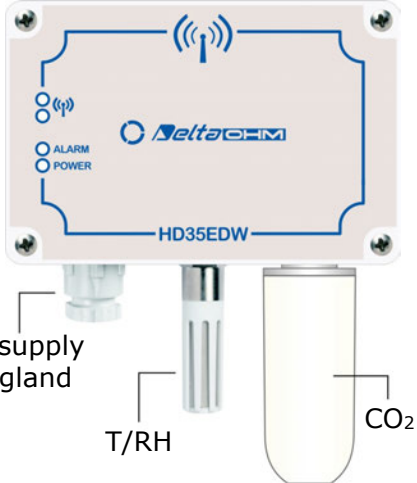
<p>HD35ED[W]...TV[I]</p>  <p>Temperature / relative humidity fixed probe</p>	<p>HD35ED[W]...TC</p>  <p>M12 connectors for external probes (the number of connectors depends on the model)</p>
<p>HD35ED4r...</p>  <p>Differential pressure inputs</p>	<p>HD35ED1NB...</p>  <p>Integrated sensors</p>

<p>HD35EDH</p>  <p>Protective cover of the terminal inputs for standard analog sensors</p>	<p>HD35EDWPM[B]</p>  <p>Fixing bracket with U-bolt</p> <p>Air outlet</p> <p>Air inlet</p> <p>HD35EDWPM[B]: 2 M12 connectors (power supply and mini-USB)</p> <p>HD35EDWPM[B]-USB: 1 M12 connector (power supply via mini-USB)</p>
<p>HD35EDW1NB...TV</p>  <p>Power supply cable gland</p> <p>T/RH</p> <p>CO₂</p>	<p>HD35EDWH / HD35EDW-MB</p>  <p>Cable glands</p>

Notes:

- Some indoor models may be equipped with mini-USB connector, on the housing side, whose use is reserved to the technical assistance.
- The outdoor models (except HD35EDWPM[B]) can optionally have an external antenna (fixed or with 3 m cable) and the solar radiations shield.
- HD35EDWPM[B]... models have no external LEDs and are not available with LCD.
- In models with multiple inputs for external probes, the number (in the case of multi-channel models for probes of the same type) or the type of input is indicated next to the input.
- In the outdoor models with cable glands, the cable gland can be PG7 or PG9 depending on the model.
- Some models can be a combination of the basic models illustrated (e.g. differential pressure inputs + fixed T/RH probe, M12 connector for external probe + fixed T/RH probe, M12 connector for external probe + cable gland, etc.).

8.2 CONNECTION TO WIRELESS NETWORK

The device can be connected and disconnected from the wireless network by **pressing for 5 seconds** the connection button. In the indoor models, the connection button is on the front panel. In the outdoor models, the connection button is internal and is indicated with CONNECT / DISCONNECT on the electronic board.

If the device is disconnected, by pressing the connection button for 5 seconds the buzzer emits a beep and the green RF LED blinks for one second to indicate the start of the connection procedure. If the device belongs to a wireless network and the base unit is reachable, once connected, the buzzer emits a second beep and the green RF LED will blink during data transmission. If the device doesn't belong to a wireless network or the base unit cannot be reached, the second beep of the buzzer is not emitted and the red RF LED will blink.

If the device is connected, by pressing the connection button for 5 seconds the buzzer emits a beep, the red RF LED activates for one second and the device is disconnected.

In data loggers with LCD display, the connection status is signaled also by the connection icon on the display (see page 8):

- the icon is steady on if the data logger is connected;
- the icon blinks if the data logger is trying to connect (the icon will be steady on once connected or will go on blinking if the base unit is not reachable or the data logger doesn't belong to a wireless network);
- if the data logger is not connected, the icon has the aspect of a hang up phone in data loggers with graphic LCD, and it is off in data loggers with custom LCD.

PING function:

In the devices connected to a wireless network it is possible to check if the base unit can be reached by briefly pressing the connection button: if the green RF LED is blinking, it means that the base unit is reachable, otherwise it will be the red RF LED to blink.

8.3 LCD DISPLAY

According to the data logger model, the LCD display can be custom (**L** option) or graphic (**G** option) type. The display shows all quantities measured and calculated by the data logger along with the following RF quantities:

- **RSSI** (*Received Signal Strength Indication*): received signal power;
- **PER** (*Packet Error Rate*): percentage of transmission errors;
- **RF Hops**: 1=direct transmission between data logger and base unit, 2= a repeater added between data logger and base unit, 3=two repeaters added, etc.

The indications of connection status, logging (in progress/deactivated), and battery charge level are displayed.

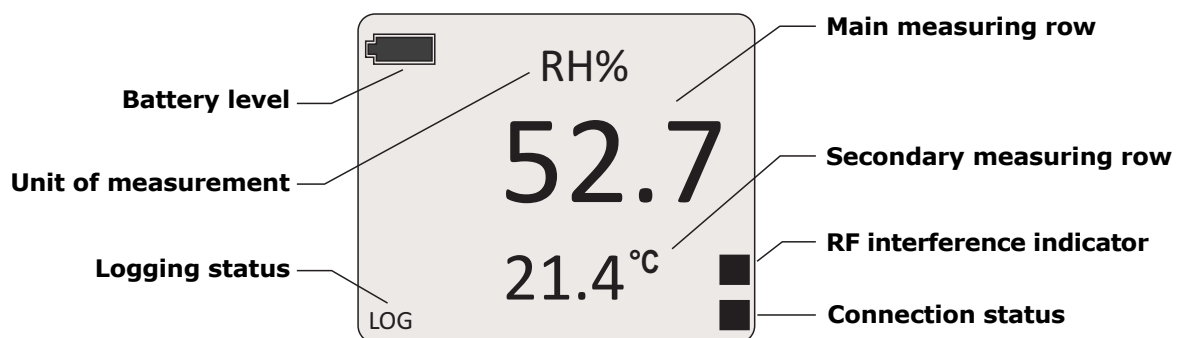

Fig. 8.3.1: custom LCD

In models with custom LCD that measure several quantities, the temperature (if measured by the model) is displayed in the secondary line, except when a RF quantity appears in the main line; in that case the secondary line shows the number of RF hops.

Models with graphic LCD allow the simultaneous display of 3 measurements in the secondary lines. The graphic display shows in addition the RF signal level and date & time.

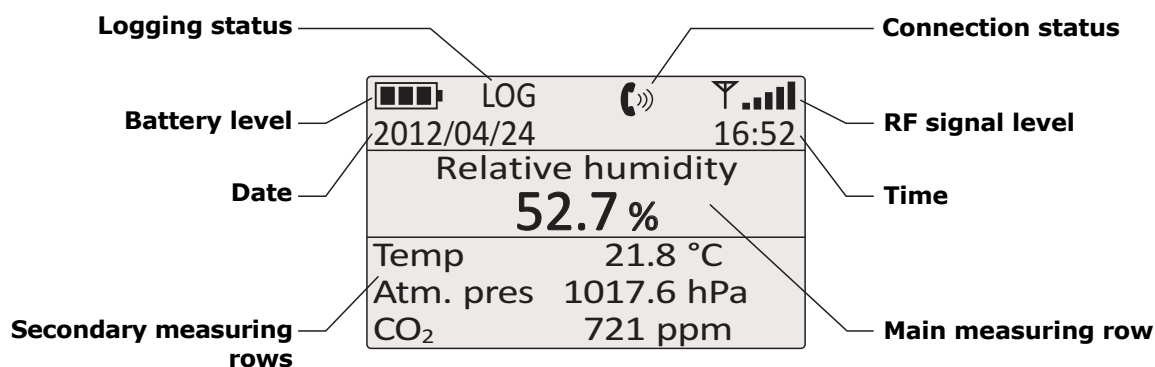

Fig. 8.3.2: graphic LCD

In the indoor models, use the ▲ key to scroll the quantities on the display. In the outdoor models, use the HD35AP-S software to select the measurement to be displayed on the main measuring row of the display or set the automatic alternation of the measured quantities.

8.4 MAXIMUM, MINIMUM AND AVERAGE OF THE MEASUREMENTS (ONLY INDOOR MODELS)

To display the maximum value (**MAX**), the minimum value (**MIN**) and the average (**AVG**) of the acquired values, press the **FUNC** key until the desired function is shown on the display.

To reinitialize the function value and start a new measuring session, press the **FUNC** key until you read *FUNC CLR* (custom LCD) or *Function clear* (graphic LCD), use the arrow keys to select yes and confirm with **ENTER**.

8.5 THE MENU IN LCD DATA LOGGERS

The menu allows displaying the data logger information and changing operation parameters. The menu is structured in levels, with main categories and submenus.

To access the menu you need to enter the **user password** (configurable through the appropriate menu item, default 0000) or the **administrator password** (supplied with the system and not editable). Entering the user password makes some settings not changeable.

The instrument exits automatically the menu if no key is pressed for 3 minutes. After exiting the menu, the password remains active for a few minutes, during which you may enter the menu again without re-entering the password. It is possible to exit the menu by disabling immediately the password by performing a password level reset in the *Password* menu.

8.5.1 The menu in data loggers with graphic LCD

To access a menu parameter proceed as follows:

1. Press **MENU**.
2. Press ▼ to select the password field.



3. Press **ENTER**, the first digit of the password will blink.
4. Use ▼/▲ keys to set the first digit and confirm with **ENTER**, the second digit of the password will blink. Set all the password digits in the same way.

5. Press ▼ to select the option OK and confirm with **ENTER**.
6. Use ▼/▲ keys to select a main category of the menu and confirm with **ENTER**.
7. If the selected main category has a submenu, select the desired item using ▼/▲ and confirm with **ENTER**.

To exit the main menu or a submenu, select the item EXIT (last menu item).

Changing a parameter

After selecting the desired parameter, it can be changed, if allowed, as follows:

1. Use ▼/▲ keys to highlight the current setting of the parameter.

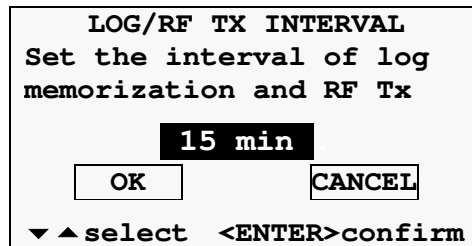

2. Press **ENTER**, the field will start blinking.
3. Use ▼/▲ keys to select the desired setting and confirm with **ENTER**. If you are setting a numeric value, you can move faster by keeping ▼ or ▲ keys depressed.
4. Press ▼ to select the option OK and confirm with **ENTER**. The instrument closes the parameter window and returns to the previous menu level.

To exit a parameter window without changes, select CANCEL and confirm with **ENTER**.

If only the option CANCEL is available in the parameter window, it means that it is not allowed to change the parameter setting.

Menu structure

The complete structure of the main window with the relevant submenus is shown below. According to the data logger model, some items could not be available if not significant for that particular model.

1) Information

It lists the general information of the instrument: model, serial number, RF address, user code, firmware version, calibration date, etc.

2) Display configuration

- 1) **Measures ordering**: changes the order for the display of the measurement quantities on the screen. To move a quantity, select it in the displayed list, press ENTER, move the quantity to the desired position and confirm with ENTER.
- 2) **Reset measures order**: choice of the default or user-defined viewing sequence.
- 3) **Exit**: returns to main menu.

3) RF Parameters

- 1) **Network Address**: network address (not RF) of the data logger. It is used to address the data logger in a Modbus network. Read-only parameter if the instrument is connected to a base unit.
- 2) **RF Channel**: used channel of the RF transmission band. Read-only parameter if the instrument is connected to a base unit.
- 3) **RF Frequency**: used RF transmission band. Only in the ...**U** models, by entering the menu with administrator password it is possible to choose the initial frequency of the RF band among 902, 915 and 921 MHz (the final frequency is always 928 MHz).

- 4) **Max number RF Hops**: maximum number of RF hops from the data logger to the base unit (equal to the number of interposed repeaters plus 1). Read-only parameter if the instrument is connected to the base unit.
- 5) **RF offline**: enables or disables the RF stage of the data logger. Activation or deactivation of the RF stage can be performed also through the connection button.
- 6) **Exit**: returns to the main menu.

4) Ch x settings (x=1, 2, 3) – Only available in the models with configurable inputs

- 1) **Ch x info**: lists all the general information of the input channel Ch x of the instrument: name of measurement, probe type, resolution. The correspondence between the input signal value and the physical quantity value is also indicated for mA, mV, V, Potentiometer and Counter inputs associated with a physical quantity.
- 2) **Ch x configuration**: sets the type of input among the available inputs (see paragraph "Inputs configuration" on page 48 for setting modes).
The input types indicated with **HR** (Pt100/Pt100 3W/4W), available in some models, have 0.01 °C resolution (the non-HR Pt100/Pt1000 input types have 0.1 °C resolution).
The input type can be set only with the administrator password.
- 3) **Ch x zero setting**: sets the current measurement value as zero value. Only available for mA, mV, V and Potentiometer inputs associated with a physical quantity.
- 4) **Ch x down threshold**: lower alarm threshold of channel x.
- 5) **Ch x up threshold**: higher alarm threshold of channel x.
- 6) **Ch x reset counter**: zeroes the number of counts. The item is available only if the channel is configured as counter.
- 7) **Exit**: returns to the main menu.

5) Alarm thresholds or Alarm configuration

- 1) **Quantity 1 (*) down threshold**: lower alarm threshold of quantity 1.
- 2) **Quantity 1 (*) up threshold**: higher alarm threshold of quantity 1.
- 3) ...
- 4) **Quantity n (*) down threshold**: lower alarm threshold of quantity n.
- 5) **Quantity n (*) up threshold**: higher alarm threshold of quantity n.
- 6) **Thres. buzzer alarm**: activates or deactivates the buzzer when measurement thresholds are exceeded.
- 7) **Exit**: returns to the main menu.

(*) The type of quantity depends on the data logger model.

Note: in the models with configurable inputs, the items down threshold and up threshold of quantities are not available in this submenu, but are included in the menus for the setting of channels Ch x.

6) Measure hysteresis

- 1) **Quantity 1 (*) hysteresis**: hysteresis of the alarm thresholds of quantity 1.
- 2) ...
- 3) **Quantity n (*) hysteresis**: hysteresis of the alarm thresholds of quantity n.
- 4) **Exit**: returns to the main menu.

(*) The type of quantity depends on the data logger model.

The width of the hysteresis is a percentage (0 ... 100%) of the difference between the two alarm thresholds.

For example, if Hysteresis=2%, Lower threshold=10 °C and Upper threshold=60 °C, the hysteresis is $(60-10) \times 2/100 = 1 \text{ °C}$:

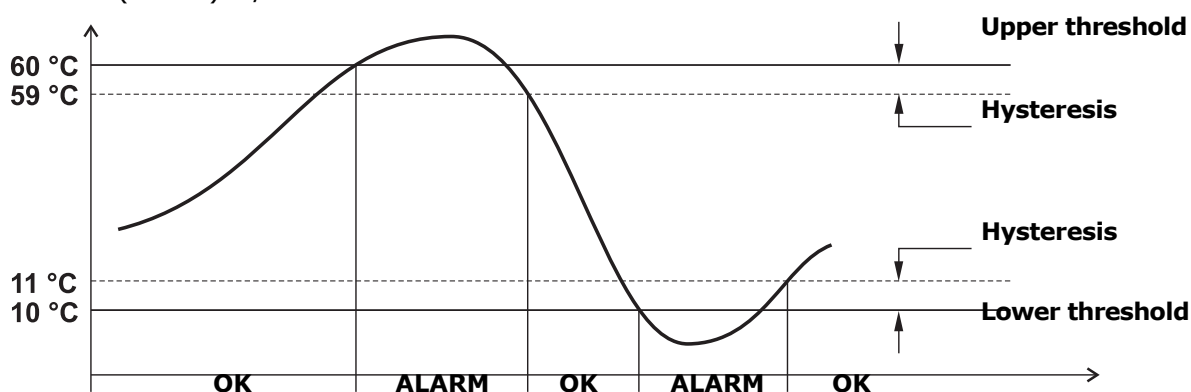

Fig. 8.5.1: hysteresis of the alarm thresholds

7) Alarm time delay (in seconds)

- 1) **Quantity 1** (*) **alarm delay**: delay for alarm activation of quantity 1.
- 2) ...
- 3) **Quantity n** (*) **alarm delay**: delay for alarm activation of quantity n.
- 4) **Exit**: returns to the main menu.

(*) The type of quantity depends on the data logger model.

If the measured value drops below the lower threshold or exceeds the upper threshold, the alarm is generated after the time set. The alarm is generated immediately if 0 is set. If the alarm condition ends before the delay time is elapsed, the alarm is not generated.

8) Unit measures

- 1) **Quantity 1** (*): measurement unit of quantity 1.
- 2) ...
- 3) **Quantity n** (*): measurement unit of quantity n.
- 4) **Exit**: returns to the main menu.

(*) The type of quantity depends on the data logger model.

Note: in the HD35EDH model, only the temperature measurement unit is available. The measurement units for the other quantities are defined during the inputs mapping procedure (if applied, see page 48).

Note: the unit of measurement is changed only on the LCD; the data are always sent in the unit of measurement set in the base unit.

9) Logging

- 1) **Start/stop log**: enables or disables logging.
- 2) **Logging mode**: choice between cyclical management (the new data overwrite the old ones when the memory is full) or non-cyclical management (logging stops when the memory is full) of the data logger memory.
- 3) **Log/RF Tx interval**: choice of logging and RF transmission interval (the two intervals coincide). If it is higher than the measuring interval, the average of the measurements acquired during the interval will be stored.
- 4) **Measure interval**: choice of the measurements acquisition interval. It is forced to the value *RF log/Tx interval* if a higher value is set.
- 5) **Log erase**: deletes all stored measurements from the data logger memory.
- 6) **Exit**: returns to the main menu.

10) Clock

- 1) **Clock Configuration**: date/time of data logger. Read-only parameter if the instrument is connected to a base unit.
- 2) **Exit**: returns to the main menu.

11) Password

- 1) **Reset password level**: exits menu disabling immediately the password (the password will not remain active for some minutes like it usually happens when exiting a menu: you will have to re-enter the password even if you access the menu at once).
- 2) **User password config.**: sets the user level password.
- 3) **Exit**: returns to the main menu.

12) CO₂ auto calibration – *Only available in models with integrated CO₂ sensor*

- 1) **Start/stop auto-calib.**: enables or disables CO₂ auto-calibration.
- 2) **Auto-calib. period**: time interval between two consecutive auto-calibrations.
- 3) **Auto-cal. 1st period**: time interval after which the first auto-calibration will be performed after activation.
- 4) **Background CO₂ value**: CO₂ reference value for auto-calibration.
- 5) **Auto-cal. max change**: maximum offset that can be applied to the measurement by the auto-calibration procedure.
- 6) **Exit**: returns to the main menu.

13) Calibration – *Only available with administrator password*

- 1) **Calibration 1** (*)
- 2) ...
- 3) **Calibration n** (*)
- 4) **Calibration Type**: choice between user calibration and factory calibration.
- 5) **Exit**: returns to the main menu.

(*) The calibrations available in the *Calibration* submenu depend on the data logger model; e.g., the *RH 75% calibration* and *RH 33% calibration* items appear in the models measuring relative humidity.

14) Language

- 1) **Language config.**: choice of the language to be used for the display.
- 2) **Exit**: returns to the main menu.

15) Exit

Returns to the measurement mode.

8.5.2 The menu in data loggers with custom LCD

To access a menu parameter proceed as follows:

1. Press **MENU**, the first digit of the password will blink.
2. Using **▼/▲** keys, set the first digit and confirm with **ENTER**, the second digit of the password will blink. Set all the password digits in the same way.
3. Using **▼/▲** keys, select a main category in the menu and confirm with **ENTER**. Menu items appear one at a time in the upper part of the display; the lower part of the display shows the position of the item in the menu and the total number of items in the menu (for ex. "8 - 10" means the eighth item in a menu of 10 items).

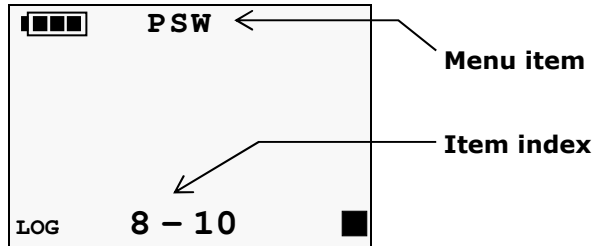

4. If the selected main category has a submenu, select the desired item using **▼/▲** keys and confirm with **ENTER**. Scrolling the submenus displays also the parameter current setting.
5. To change the selected parameter, if allowed, use **▼/▲** keys to select the desired setting and confirm with **ENTER**. If you are setting a numeric value, you can fast forward by keeping **▼** or **▲** keys depressed.

To exit the main menu or a sub menu, select EXIT item (last menu item).

If it is not allowed to change a parameter, the notice N/A (Not Available) will appear when pressing ENTER to select it.

Menu structure

The complete structure of the main menu with the relevant submenus is shown below. According to the data logger model, some items could be not available if not significant for that particular model.

1) DEV_INFO (information)

It lists the general information of the instrument: model, serial number, RF address, user code, firmware version, calibration date, etc. Information is shown in the upper part of the display.

2) DISP_MENU (display configuration)

- 1) **DISP_LOOP_FOR_MEAS**: enables or disables the cyclical display of the measured quantities. Select **YES** to activate the cyclical display. The menu item is available only if the data logger measures two or more quantities, in addition to temperature.
- 2) **EXIT**: returns to the main menu.

3) RF_MENU (RF parameters)

- 1) **NET_ADDR**: network address (not RF) of the data logger. It is used to address the data logger in a Modbus network. Read-only parameter if the instrument is connected to a base unit.
- 2) **RF_CHAN**: used channel of RF transmission band. Read-only parameter if the instrument is connected to a base unit.
- 3) **RF_FREQ_MHZ**: used RF transmission band. Only in the **...U** models, by entering the menu with administrator password it is possible to choose the initial frequency of the RF band among 902, 915 and 921 MHz (the final frequency is always 928 MHz).
- 4) **MAX_NUM_RF_HOPS**: RF hops maximum number from data logger to base unit (equal to the number of interposed repeaters plus 1). Read-only parameter if the

instrument is connected to a base unit.

- 5) **RF_OFF_LINE**: enables or disables the RF stage of the data logger. Select *NO* to activate the RF stage. Activation or deactivation of the RF stage can be done also through the connection button.
- 6) **EXIT**: returns to the main menu.

4) **THLD_MENU** (alarm thresholds)

- 1) **Quantity 1 (*)_DOWN_THLD**: lower alarm threshold of quantity 1.
- 2) **Quantity 1 (*)_UP_THLD**: higher alarm threshold of quantity 1.
- 3) ...
- 4) **Quantity n (*)_DOWN_THLD**: lower alarm threshold of quantity n.
- 5) **Quantity n (*)_UP_THLD**: higher alarm threshold of quantity n.
- 6) **THLD_ALARM**: enables or disables the buzzer when measurement thresholds are exceeded.
- 7) **EXIT**: returns to the main menu.

(*) The type of quantity depends on the data logger model.

5) **HYST_MENU** (hysteresis of the alarm thresholds)

- 1) **Quantity 1 (*)_HYST%**: hysteresis of the alarm thresholds of quantity 1.
- 2) ...
- 3) **Quantity n (*)_HYST%**: hysteresis of the alarm thresholds of quantity n.
- 4) **EXIT**: returns to the main menu.

(*) The type of quantity depends on the data logger model.

The width of the hysteresis is a percentage (0 ... 100%) of the difference between the two alarm thresholds.

For example, if Hysteresis=2%, Lower threshold=10 °C and Upper threshold=60 °C, the hysteresis is $(60-10) \times 2 / 100 = 1$ °C (see the example graph on page 41).

6) **ALRM_DELY_MENU** (delay time in seconds for alarm activation)

- 1) **Quantity 1 (*)_ALRM_DELY**: delay for alarm activation of quantity 1.
- 2) ...
- 3) **Quantity n (*)_ALRM_DELY**: delay for alarm activation of quantity n.
- 4) **EXIT**: returns to the main menu.

(*) The type of quantity depends on the data logger model.

If the measured value drops below the lower threshold or exceeds the upper threshold, the alarm is generated after the time set. The alarm is generated immediately if 0 is set. If the alarm condition ends before the delay time is elapsed, the alarm is not generated.

7) **MEAS_UNIT_MENU** (measurement unit)

- 1) **Quantity 1 (*)_UNIT_MEAS**: measurement unit of quantity 1.
- 2) ...
- 3) **Quantity n (*)_UNIT_MEAS**: measurement unit of quantity n.
- 4) **EXIT**: returns to the main menu.

(*) The type of quantity depends on the data logger model.

Note: the unit of measurement is changed only on the LCD; the data are always sent in the unit of measurement set in the base unit.

8) LOG_MENU (logging)

- 1) **LOG_STAT**: enables or disables the logging.
- 2) **LOG_CYCL**: choice between cyclical management (the new data overwrite the old ones when the memory is full) or non-cyclical management (logging stops when the memory is full) of the data logger memory. Select *YES* for the cyclical management.
- 3) **LOG/RF_TIME**: choice of logging and RF transmission interval (the two intervals coincide). If it is higher than the measuring interval, the average of the measurements acquired during the interval will be stored.
- 4) **MEAS_TIME**: choice of the measurements acquisition interval. It is forced to the value *Log/RF_TIME* if a higher value is set.
- 5) **LOG_DEL**: deletes all stored measurements from the data logger memory. Select *YES* to delete the memory.
- 6) **EXIT**: returns to the main menu.

9) CLK_MENU (clock)

- 1) **YEAR**: year. Read-only parameter if the instrument is connected to a base unit.
- 2) **MON**: month. Read-only parameter if the instrument is connected to a base unit.
- 3) **DAY**: day. Read-only parameter if the instrument is connected to a base unit.
- 4) **HOURL**: hour. Read-only parameter if the instrument is connected to a base unit.
- 5) **MIN**: minutes. Read-only parameter if the instrument is connected to a base unit.
- 6) **EXIT**: returns to the main menu.

10) PSW_MENU (password)

- 1) **RST_PSW_LVL**: exits the menu and deactivates immediately the password (the password will not remain active for some minutes as it normally happens when exiting the menu: you will need to re-enter the password even if you re-access immediately the menu).
- 2) **SET_NEW_PSW**: sets user-level password.
- 3) **EXIT**: returns to the main menu.

11) CAL_MENU (calibration) – *Only available with administrator password*

- 1) **Calibration 1** (*)
- 2) ...
- 3) **Calibration n** (*)
- 4) **CAL_TYPE**: choice between user calibration (*USER*) or factory calibration (*FACT*).
- 5) **EXIT**: returns to the main menu.

(*) The calibrations available in the *CAL_MENU* submenu depend on the data logger model; e.g., the *RH_75%_CAL* and *RH_33%_CAL* items appear in the models measuring relative humidity.

12) EXIT

Returns to measurement mode.

8.6 M12 CONNECTORS PIN-OUT

The following figures show the external side of the data logger M12 connector. The arrow indicates the connector reference notch.

Connector for rain gauges and pyranometers:

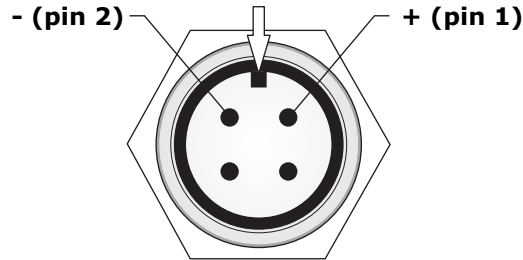

Connector for HP3501 and HP3510... probes:

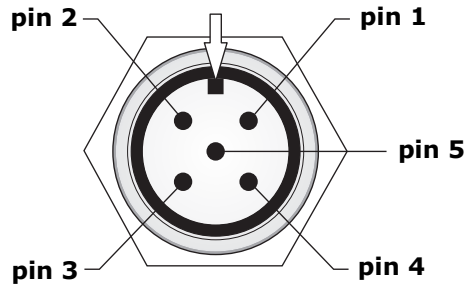

M12 connector pin	Description
1	Upper surface output positive (HP3501...) %VWC output positive (HP3510...)
2	Not connected
3	GND
4	Lower surface output positive (HP3501...) Temperature output positive (HP3510...)
5	Power supply positive

Connector for temperature probes:

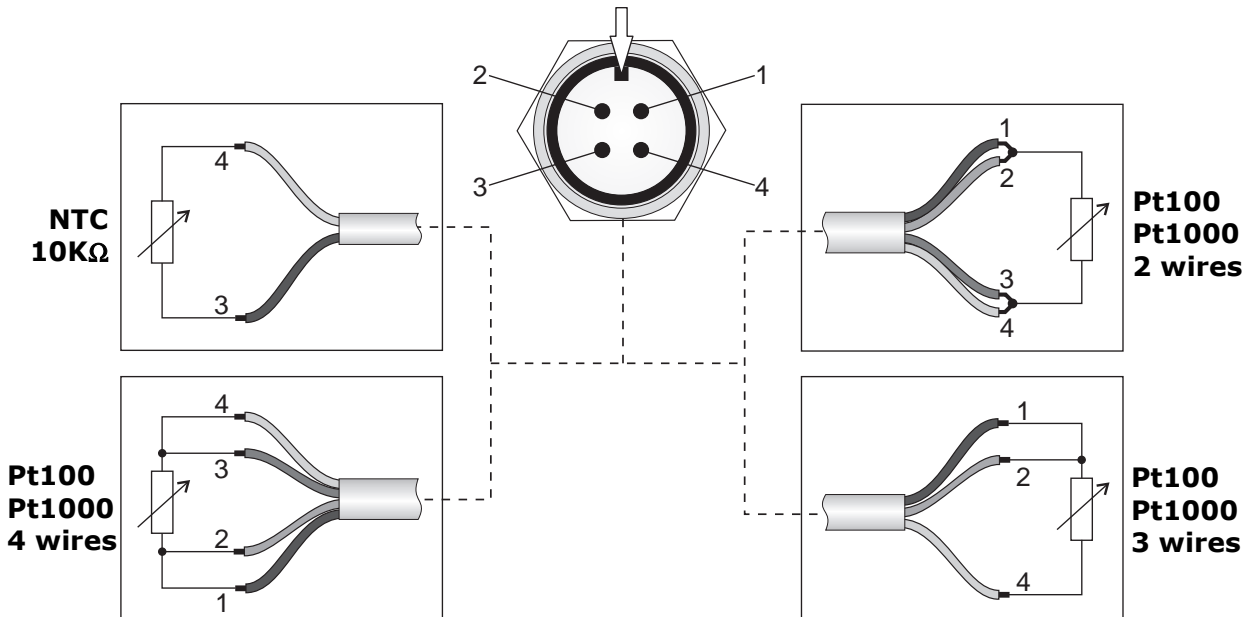

Connector for combined temperature and relative humidity probes:

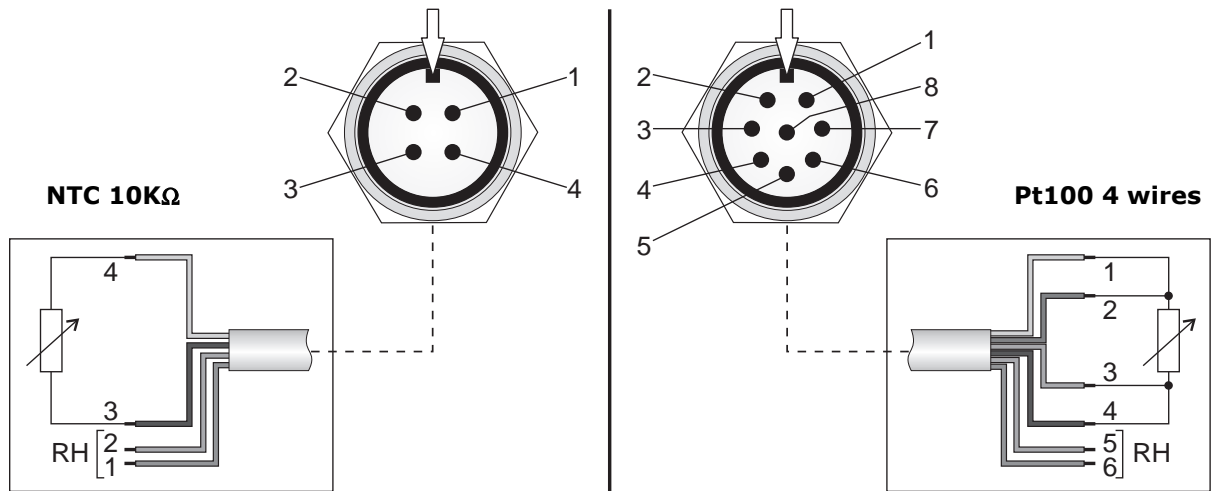

WARNING: to the data loggers that use the HP3517... combined T/RH probe must be connected the probe with the same serial number as the data logger (if purchased together). The replacement of the probe requires recalibration of the instrument in line with the new probe.

HD35EDWPM[B] power supply connector:

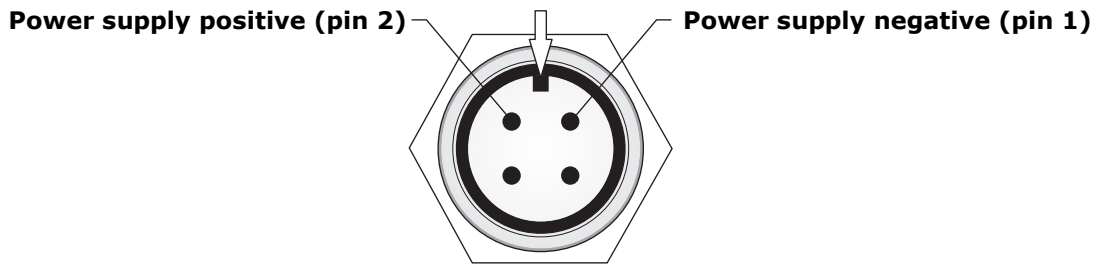

8.7 CONNECTIONS IN THE INDOOR MODEL HD35ED[G]H

HD35ED[G]H has three terminal header inputs. Each input can be configured as a Pt100/Pt1000, thermocouple, 0/4...20 mA (shunt resistance inside), 0...50 mV, 0...1 V or potentiometric input. Only input 3 can be also configured as pulse counter (count of voltage-free contact switchings).

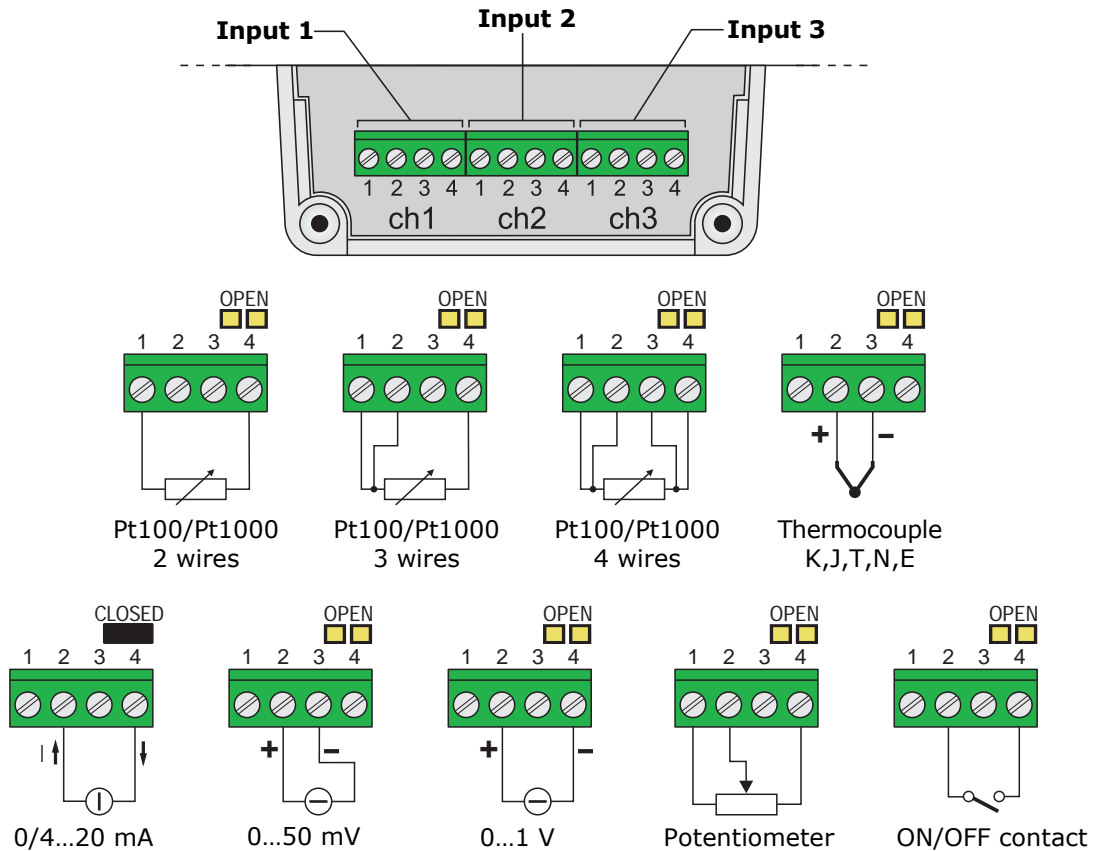

Fig. 8.8.1: sensor connection in HD35ED[G]H

If a channel is configured as current input, insert the 50 Ω shunt resistance closing the jumper placed on the terminals of the relevant channel. In all the other configurations, leave the jumper open. The current input accepts any value in the range 0...20 mA.

Inputs configuration

Configuration of inputs can be implemented through the HD35AP-S software (see software instructions) or, if the data logger is equipped with a display, through the front keyboard.

To configure the input channel ch x ($x=1,2,3$ is the number of the input) through the keyboard, access the menu and select the item *Ch x settings* \Rightarrow *ch x configuration*. Set the type of input among those available:

- Pt100 2-wire, Pt100 3-wire, Pt100 4-wire, Pt1000 2-wire, Pt1000 3-wire, Pt1000 4-wire;
- TC-K, TC-J, TC-T, TC-N, TC-E;
- 0-1V, 0-50mV, 4-20mA, Potentiometer, Counter, Frequency;
- 0-1V Mapped, 0-50mV Mapped, 4-20mA Mapped, Mapped Potent., Mapped Count., Mapped Freq.

The input types *4-20mA* and *4-20mA Mapped* also work with 0-20 mA signals. The input types *Counter* and *Frequency* are only in channel Ch 3.

Set *NO MEASURE* if the channel is not used.

The indication *Mapped* means that a linear correspondence between input values (in mA, mV, V, Ω or counts) and the values of a physical quantity will be associated to the channel. For ex-

ample, if *4-20mA* is selected, the data logger stores the input value in mA; if *4-20mA Mapped* is selected, the data logger doesn't store the input value in mA but the corresponding value of the physical quantity associated to the input.

By selecting a Mapped-type configuration, the guided procedure for the association between the input values (in mA, mV, V, Ω or counts) and the values of the corresponding physical quantity is started. The procedure is illustrated below:

1. After confirming the selection of a Mapped input, the procedure start message is displayed, press **ENTER** to continue.
2. Select the measurement unit of the physical quantity among those proposed by the instrument. If the desired measurement unit is not in the list, select *NOT DEF* (not defined). Select the option OK and confirm with **ENTER** to continue.
3. Select the measurement resolution of the physical quantity among those proposed by the instrument. Select the option OK and confirm with **ENTER** to continue.
4. A message will be displayed reminding that the two coordinates of the linear relation between input and physical quantity will be now required:
 - x1=input value (in mA, mV, V, Ω or counts) in the first point,
 - y1=value of the physical quantity corresponding to the input value x1,
 - x2=input value (in mA, mV, V, Ω or counts) in the second point,
 - y2=value of the physical quantity corresponding to the input value x2,

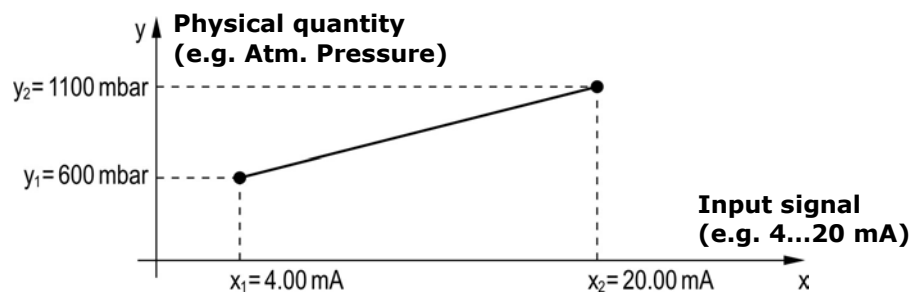

Fig. 8.8.2: association of a physical quantity to the input signal

press **ENTER** to continue.

5. Select the input value x1 for the first point (e.g. 4.00 mA). Select the option OK and confirm with **ENTER** to continue.
6. Select the physical quantity value y1 for the first point (e.g. 600 mbar). Select the option OK and confirm with **ENTER** to continue.
7. Select the input value x2 for the second point (e.g. 20.00 mA). Select the option OK and confirm with **ENTER** to continue.
8. Select the physical quantity value y2 for the second point (e.g. 1100 mbar). Select the option OK and confirm with **ENTER** to continue.
9. The message requesting confirmation of the configuration storage is displayed, press **YES** to save the settings and terminate the procedure.

The procedure can be stopped at any moment by selecting the option CANCEL and confirming with **ENTER**.

A user name can be associated to each measurement channel to remind the type of physical quantity detected. The user name can be set only through the HD35AP-S software.

8.8 CONNECTIONS IN THE OUTDOOR MODEL HD35ED[L]WH

HD35ED[L]WH has four terminal header inputs. Each input can be configured as a Pt100/Pt1000, thermocouple, 0/4...20 mA (shunt resistance inside), 0...50 mV, -50...50 mV, 0...1 V, 0...10 V or potentiometric input. Only input 4 can be also configured as pulse counter (count of voltage-free contact switchings).

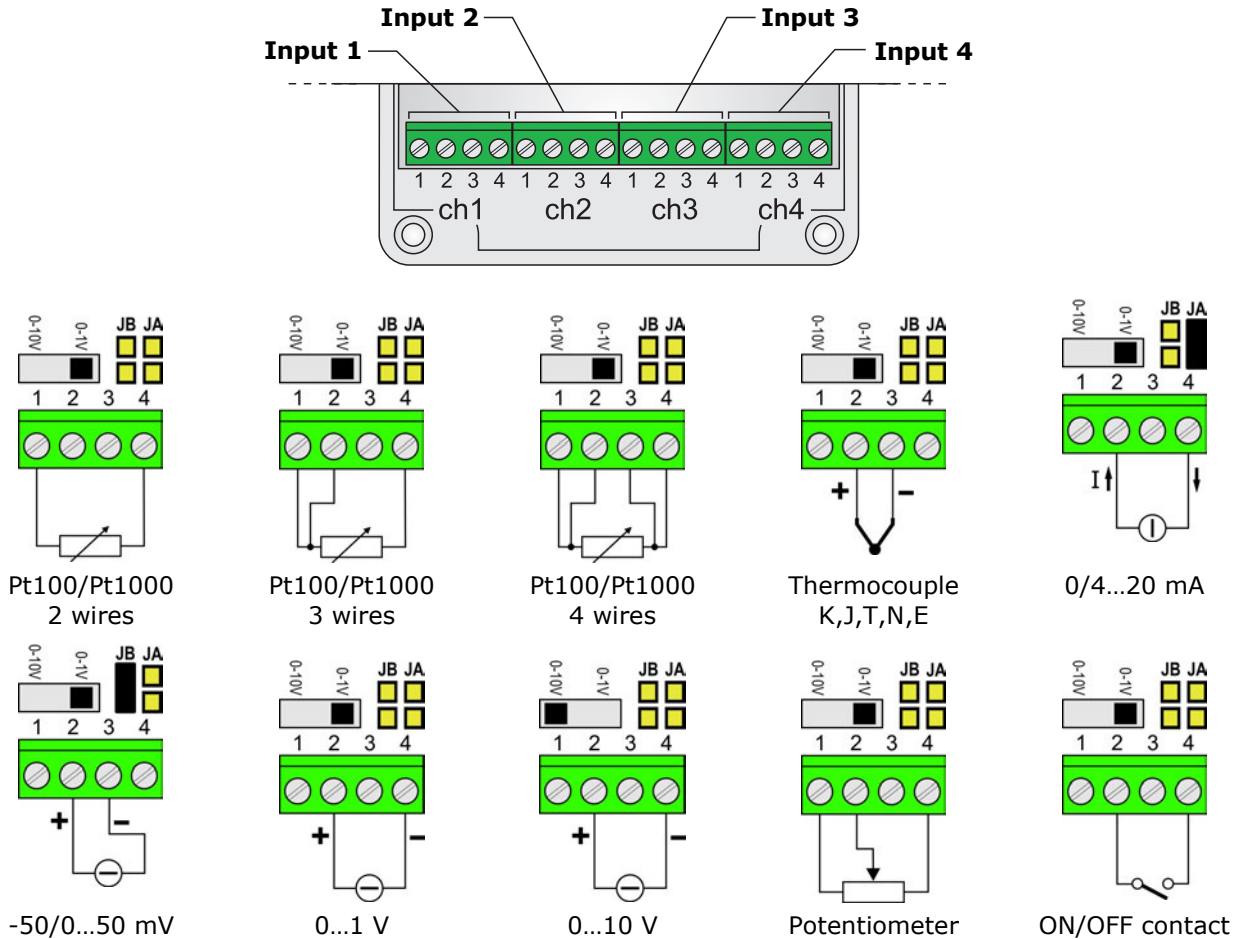

Fig. 8.9.1: sensor connection in HD35ED[L]WH

If a channel is configured as 0-10 V input, set the switch on the terminals of the channel to 0-10V. In all other cases, set the switch to 0-1V.

If a channel is configured as current input, insert the 50 Ω shunt resistance closing the jumper **JA** placed above the terminals of the relevant channel. In all the other configurations, leave the jumper open. The current input accepts any value in the range 0...20 mA.

If a channel is configured as -50/0...50 mV input, close the jumper **JB** placed above the terminals of the relevant channel (*note*: alternatively, if the jumper JB is not present, short-circuit terminals 1 and 3 of the input). In all the other configurations, leave the jumper open.

Configuration of inputs is done with the HD35AP-S software (see software instructions).

Power supply

Power the data logger paying attention to the model:

- HD35ED[L]WH has internal battery: connect the battery to the connector indicated with **BATT** on the electronic board.
- HD35ED[L]WHE requires 7...28 Vdc external power supply: connect the external power supply to the terminals indicated with **PWR** on the electronic board, paying attention to the correct polarity indicated on the board.

8.9 CONNECTIONS IN THE OUTDOOR MODEL HD35ED[L]W-MB

HD35ED[L]W-MB has:

- 7...30 Vdc power supply input (terminals 1, 2).
- Switched power supply output (terminals 3, 4). It has the same value as the power supply input, but it is **active only during the measurement acquisition phase**. The output can be used to power the sensors.
- RS485 port (terminals 5, 6, 7) with Modbus-RTU protocol for the connection of the sensors.
- Potential-free contact input (terminals 8, 9). For example, a rain gauge with contact output can be connected.

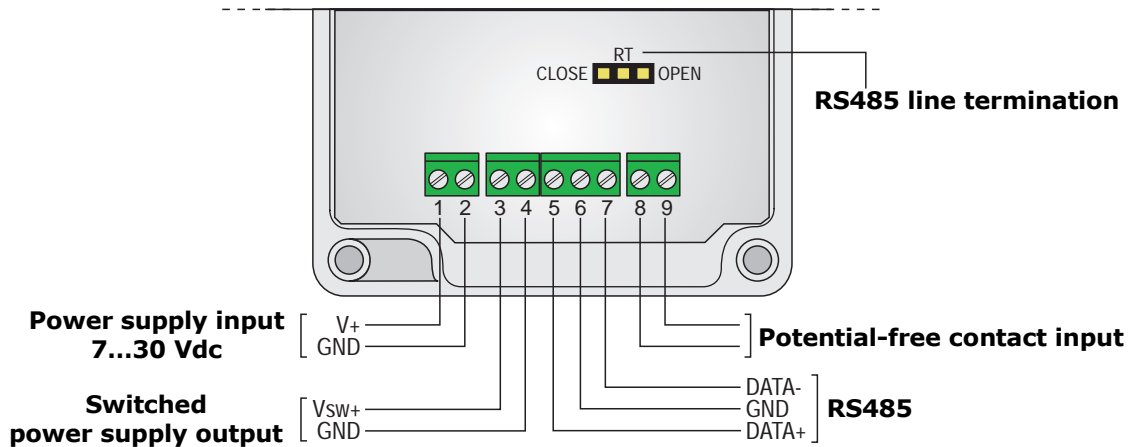

Fig. 8.7.1: HD35ED[L]W-MB connections

The jumper placed above the terminals allows inserting the termination resistance for long distance RS485 connection. Place the jumper between the **RT** and **CLOSE** indications to connect the termination resistance. Place the short jumper between the **RT** and **OPEN** indications to disconnect the resistance.

Note: in HD35ED[L]W-MB, near the connection button (CONNECT/DISCONNECT) there are a switch (RUN/PROG) and a button (RF RESET) used to update the firmware. In normal operation, leave the switch in RUN position.

8.10 HP712 LEVEL SENSOR CONNECTION (FOR HD35ED[L]WDPTC)

Terminal	Description	sensor wire color (*)
9	GND	White
10	Sensor output positive	Green
12	Sensor power supply positive	Brown

(*) The colors may be subject to change: always check the sensor data sheet.

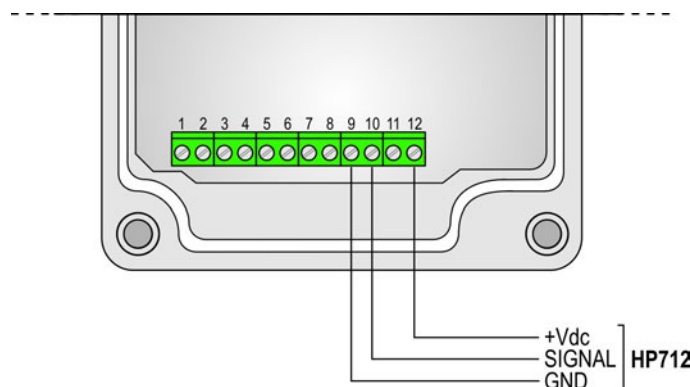

Fig. 8.10.1: HP712 level sensor connection

8.11 CALIBRATION

The data logger is factory-calibrated and does not normally require further interventions of the user. Anyway, a new calibration of some sensors can be performed.

For a correct calibration, it is crucial to know and respect the physical phenomena which underlie measurements: for this reason, it is recommended to thoroughly follow the following instructions and to perform new calibrations only if in possession of adequate technical knowledge and instruments.

To access calibration, the data logger must have the user-calibration option set:

- In indoor models with graphic LCD, select the menu item *Calibration* ⇒ *Calibration Type* and set the *User* option.
- In indoor models with custom LCD, select the menu item *CAL_MENU* ⇒ *CAL_TYPE* and set the *User* option.

The calibration procedure deletes the data of the previous user calibration. In case of failed procedure, you can always return the instrument to factory calibration by selecting:

- In indoor models with graphic LCD, the menu item *Calibration* ⇒ *Calibration Type* and setting the *Factory* option;
- In indoor models with custom LCD, the menu item *CAL_MENU* ⇒ *CAL_TYPE* and setting the *FACT* (factory) option.

Calibration can be performed with HD35AP-S software (see software instructions) or, if the data logger has display and keyboard, through the front keyboard.

8.11.1 CO₂ CALIBRATION

The CO₂ sensor can be calibrated to any reference value within the measurement range.

In the outdoor models, to calibrate the CO₂ sensor at 0 ppm with the aid of the cylinder, unscrew the probe filter, screw the **HD31.B3A** adapter and connect the cylinder; adjust the bottle flow meter to get a constant flow between 0.3 and 0.5 l/min.

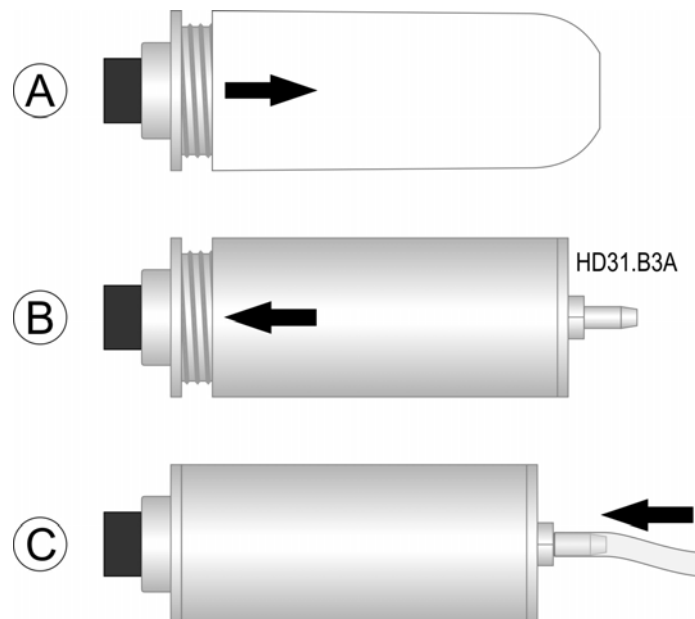



Fig. 8.11.1: adapter for CO₂ calibration with cylinder

Calibration procedure:

1. Place the instrument in an environment with known CO₂ concentration (for ex. in clean air).
2. Wait for at least 15 minutes for the measurement to become stable, with the instrument on.
3. Access the menu with the administrator password and select the item *Calibration* ⇒ *CO₂ calibration*. Press **ENTER** to confirm.
4. The value measured by the instrument appears on the left, and the calibration point on the right. The instrument initially proposes the same measurement value as calibration point.
5. Enter the calibration value, select the option OK and confirm with **ENTER**.

CO ₂ CALIBRATION	
Put sensor in known gas concentration	
Meas. [ppm]	Cal. [ppm]
472	450
OK	CANCEL
▼ ▲ select <ENTER>confirm	

6. The instrument tests the measurement stability. Wait for a few minutes for measurement completion. In the meantime, don't stay too close to the instrument to avoid altering the measurement.

WAIT FOR STABILIZATION OF CO ₂ CONCENTRATION...	
Please stay away to not alter measures	
Meas. [ppm]	Avg [ppm]
472	----
	

7. At the end, a message is shown indicating the calibration success or failure. Press any key to return to the calibration submenu.

If a message appears declaring that calibration has failed, it means that the value measured by the instrument during the procedure differs too much from the set reference value. In that case repeat calibration checking the CO₂ reference value in the environment and making sure to operate in a stable environment.

CO₂ sensor auto-calibration (only HD35ED1[4b]NB)

The instrument can be set so as CO₂ calibration is automatically performed at predetermined intervals.

In order for auto-calibration to be effective, the CO₂ concentration in the environment where the instrument is installed must assume a known value (referred to as environment **background value**). For example, we can have that an instrument installed inside a public place performs a weekly auto-calibration when people are not present and CO₂ concentration is close to the outdoor air value (if there is an adequate air change).

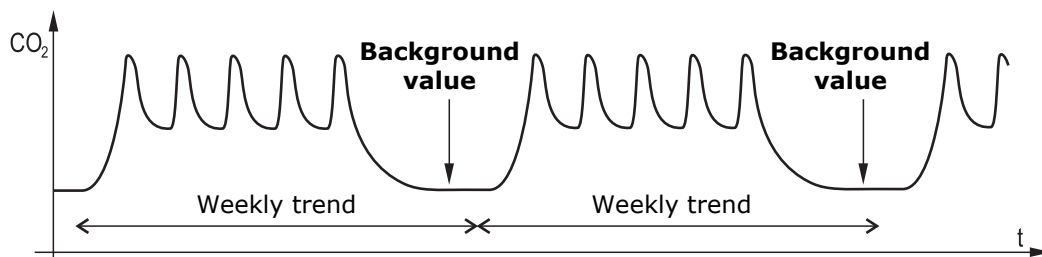

Fig. 8.11.2: example of background value for CO₂ auto-calibration

The offset applied to the measurement by the auto-calibration procedure can be limited to a maximum value, so as to avoid erroneous calibrations when the measured value differs too much from the estimated background value. The auto-calibration procedure acts as follows:

- If the difference between the measured value and the background value is lower than the maximum offset, an offset is applied to the measurement so that the measured value coincides with the background value.
- If the difference between the measured value and the background value is higher than the maximum offset, only the maximum offset is added or subtracted so as to approach the background value.

To set the auto-calibration interval and maximum offset, and to activate auto-calibration, see the menu item *CO₂ autocalibration*.

8.11.2 DIFFERENTIAL PRESSURE CALIBRATION

Differential pressure sensors may show a slight difference between the two inputs, consequently the instrument, with an equal pressure applied to the two inputs, doesn't show a zero value.

If the data logger is equipped with the auto-zero function, zeroing is automatic. To carry out the manual zeroing instead, proceed as follows.

Calibration procedure:

1. Leave the instrument pressure input open.
2. Access menu with the administrator password and select the item *CAL_MENU* ⇒ *DIFF_PRES_0 Pa_CAL*. Press **ENTER** to confirm.
3. The zero value blinks on the display.

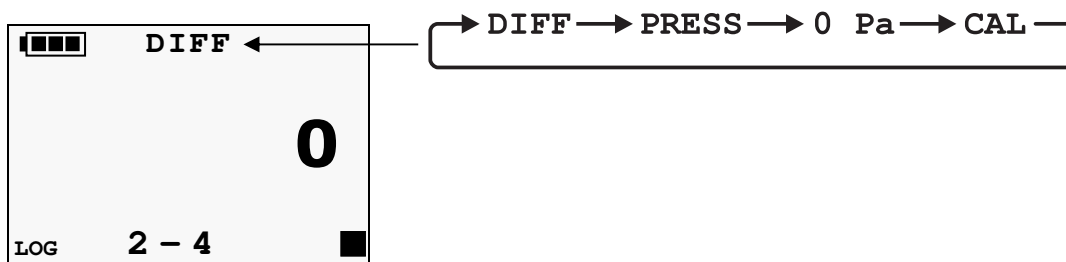

4. Press **ENTER**, the instrument stores the calibration and returns to the calibration submenu.

8.11.3 RELATIVE HUMIDITY CALIBRATION

The sensor can be calibrated in the two points 75%RH and 33%RH. Before starting the calibration procedure, it's better to **check** if a new calibration is necessary, with the aid of 75.4%RH and 33%RH saturated solutions (except HD35ED[G]...B models, that require a climatic chamber): a calibration will be performed only if an error of a few humidity points in one of the two calibration points is detected.

The sensor can be calibrated in both points or in one point only.

Preliminary operations before calibration:

Check that the chamber with the saturated saline solutions contains at the same time:

- solid state salt,
- liquid solution or wet salt, in particular for the 75%RH solution.

The instrument and the saturated solutions to be used for this operation must be placed in a stable temperature environment for the whole calibration period. Wait for at least a couple of hours with a stable temperature so that the instrument and the saturated solutions reach a thermal balance with the environment before starting the calibration procedure. In order to obtain a good calibration, it is crucial that the probe and the solution have the same temperature.

Bear in mind that plastic material is a bad heat conductor.

Calibration should be performed at a temperature ranging within 15 and 30°C.

Calibration procedure:

1. Unscrew the probe protection grid and screw the M12×1 threaded ring.
Avoid any contact of the sensitive element with your hands or other objects or liquids. **If some liquid has formed inside the measuring chamber, dry it with a clean absorbent paper towel.**
2. Unscrew the cap of the saturated solution. Screw the threaded ring with the probe on the saturated solution container and wait for at least 30 minutes.
3. Access the menu with the administrator password and select the item *CAL_MENU* (custom LCD) or *Calibration* (graphic LCD). Press **ENTER** to confirm.
4. Select the item *RH_75%_CAL* (custom LCD) or *RH 75% calibration* (graphic LCD) to calibrate the point 75%RH; select the item *RH_33%_CAL* (custom LCD) or *RH 33% calibration* (graphic LCD) to calibrate the point 33%RH. Press **ENTER** to confirm.
5. In the models with custom LCD, the blinking value of the saturated solution at the temperature measured by the probe is displayed. In the models with graphic LCD, the value measured by the instrument (on the left) and the calibration point (on the right) appear.

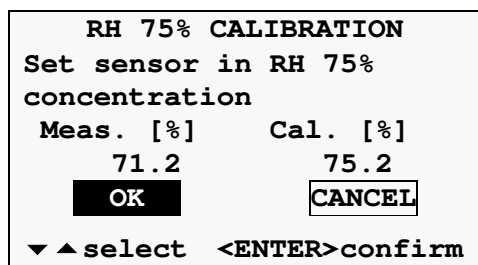

Graphic LCD

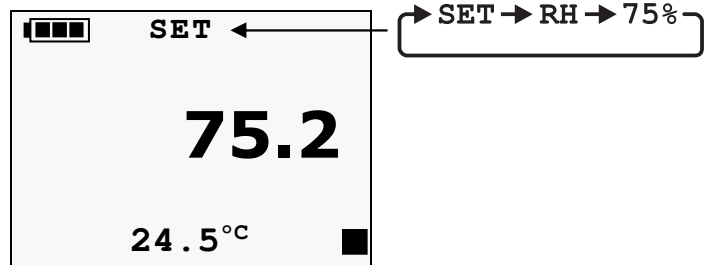

Custom LCD

Note: the suggested calibration value is not updated if the measured temperature changes after starting calibration. If necessary, set manually the calibration value to the value of the saturated solution at the measured temperature using ▼/▲ keys (see the table on the saturated solution container).

6. In the models with custom LCD, press **ENTER** to confirm the value; in the models with graphic LCD, select the option OK and confirm with **ENTER**. The instrument stores the calibration and returns to the calibration submenu.
7. Remove the threaded ring with the probe from the container of the saturated solution and close the container with the solution.
8. To calibrate the second point, repeat the procedure from step 2 to step 7 with the second saturated solution (*Note:* in the HD35ED...TVI models, for a better accuracy, calibrate the second point at a temperature close to that of the first point).
9. Unscrew the M12X1 threaded ring from the probe and place again the sensor protection grid.

8.11.4 PHOTOMETRIC PROBE SENSITIVITY SETTING

If the photometric probe is replaced, set in the data logger the sensitivity of the new probe as follows.

1. Access menu with the administrator password and select the item *CAL_MENU* ⇒ *LGHT_SENS_PA_LUX*.
2. Press **ENTER**, the current sensitivity value blinks on the display.
3. Set the new value (in pA/lux) by using the ▼/▲ keys.
4. Press **ENTER**, the instrument returns to the calibration submenu.

8.12 WBGT INDEX MEASUREMENT (HD35ED[L]WWBGT MODEL)

HD35ED[L]WWBGT can contemporarily detect the following quantities:

- Globe thermometer temperature **T_g**
- Natural ventilation wet bulb temperature **T_{nw}**
- Ambient temperature **T_a**

On the basis of the detected measurements, the instrument can calculate:

- **WBGT_{indoor}** index: WBGT index in absence of solar irradiation.

$$\mathbf{WBGT_{indoor} = 0.7 T_{nw} + 0.3 T_g}$$

- **WBGT_{outdoor}** index: WBGT index in presence of solar irradiation.

$$\mathbf{WBGT_{outdoor} = 0.7 T_{nw} + 0.2 T_g + 0.1 T_a}$$

The **WBGT** (Wet Bulb Globe Temperature) index is one of the indexes used for determining the thermal stress to which an individual is submitted to in a warm environment. For WBGT index measurement, refer to ISO 7243 standard.

To calculate WBGT index according to ISO 7243 standard, it's necessary that to the instrument are connected:

- **TP3501TC2** or **TP3204** natural ventilation wet bulb temperature probe.
- **TP3576TC2** or **TP3575TC2** globe thermometer.
- **TP3507TC2** dry bulb temperature probe if the detection is made in presence of solar irradiation.

Preparation of the TP3576TC2 or TP3575TC2 globe thermometer:

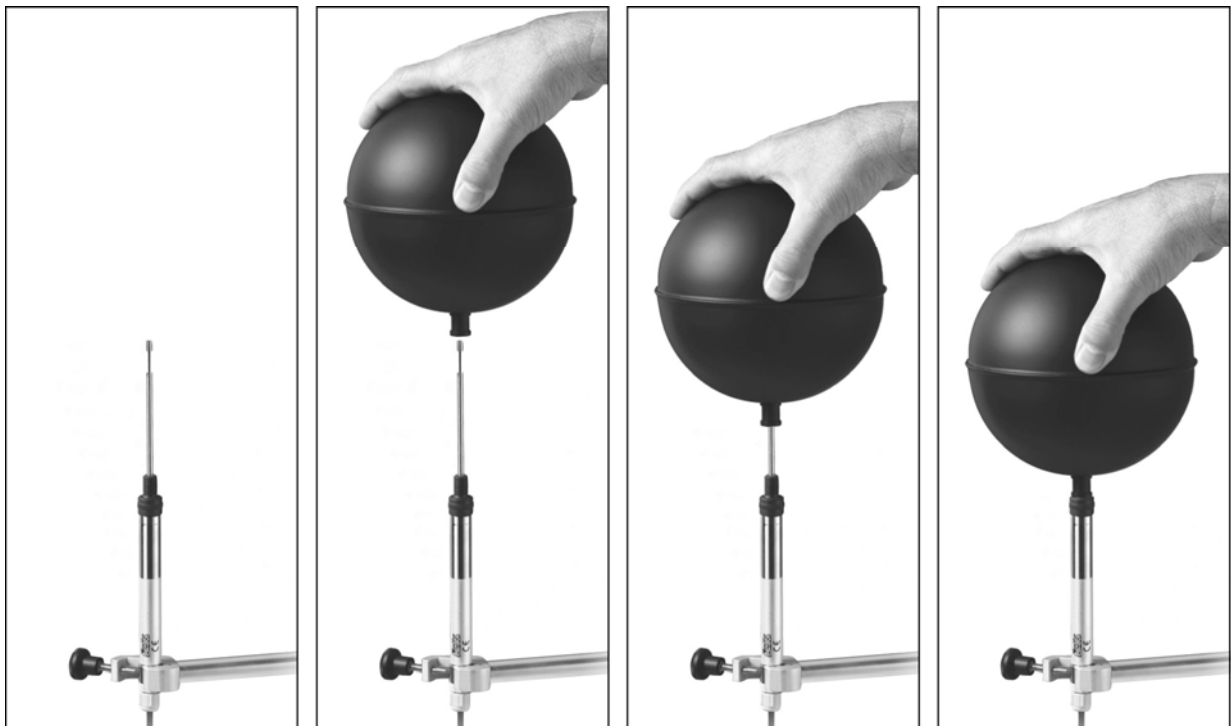

Preparation of the TP3501TC2 wet bulb temperature probe:

1. Remove the sensor cap (the cap is not screwed).
2. Insert the cotton wick, previously dipped with distilled water, into the temperature probe. The cotton wick must protrude from the probe for about 20 mm.
3. Fill the reservoir up till $\frac{3}{4}$ with **distilled water**.
4. Replace the cap.

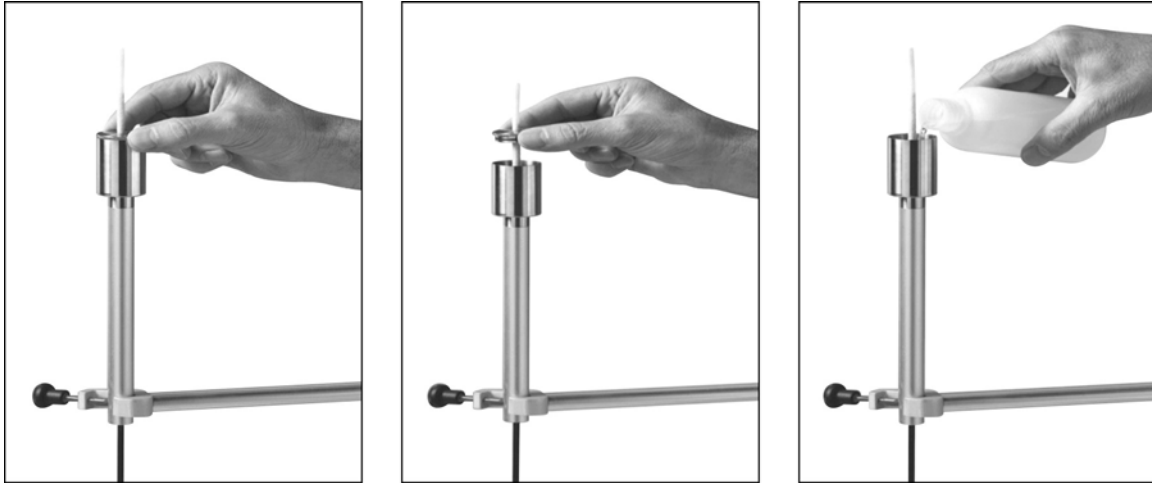

Warning: keep the probe vertical to prevent water from leaking.

Note: over time the cotton wick tends to calcify (harden): it must be replaced periodically.

Preparation of the TP3204 wet bulb temperature probe:

1. Remove the sensor cap (the cap is not screwed).
2. Insert the cotton wick, previously dipped with distilled water, into the temperature probe. The cotton wick must protrude from the probe for about 20 mm.
3. Replace the cap.
4. Fill the bottle with 500 cc of **distilled water**.
5. Turn the probe over and firmly screw the bottle to the probe reservoir.
6. Turn the probe quickly (to avoid water spillage).
7. Secure the probe to the **HD32.2.7.1** support by using the two screws at the bottom of the probe.

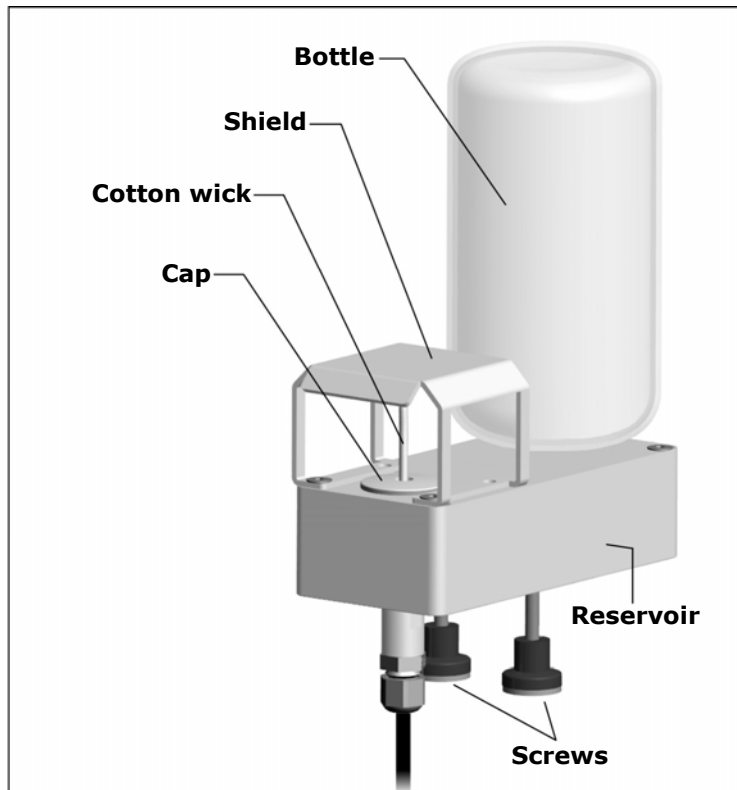
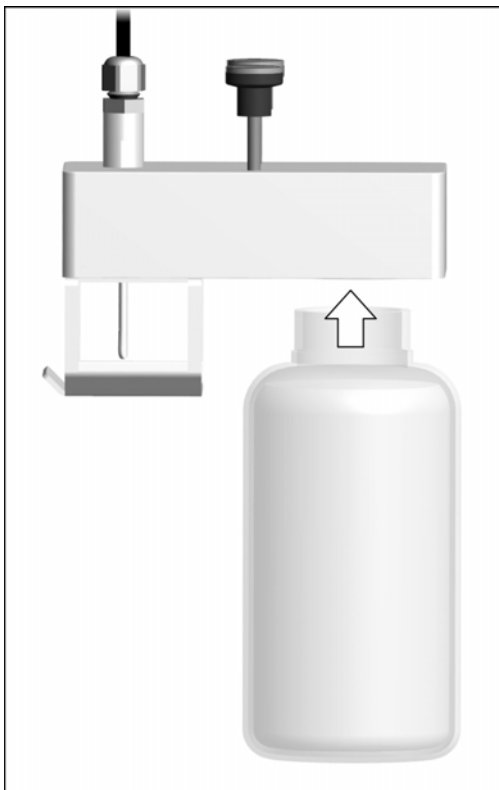

For measurements in presence of solar irradiation, use the protection shield from solar radiations.

Note: over time the cotton wick tends to calcify (harden): it must be replaced periodically.

Installation on HD32.2.7.1 support:

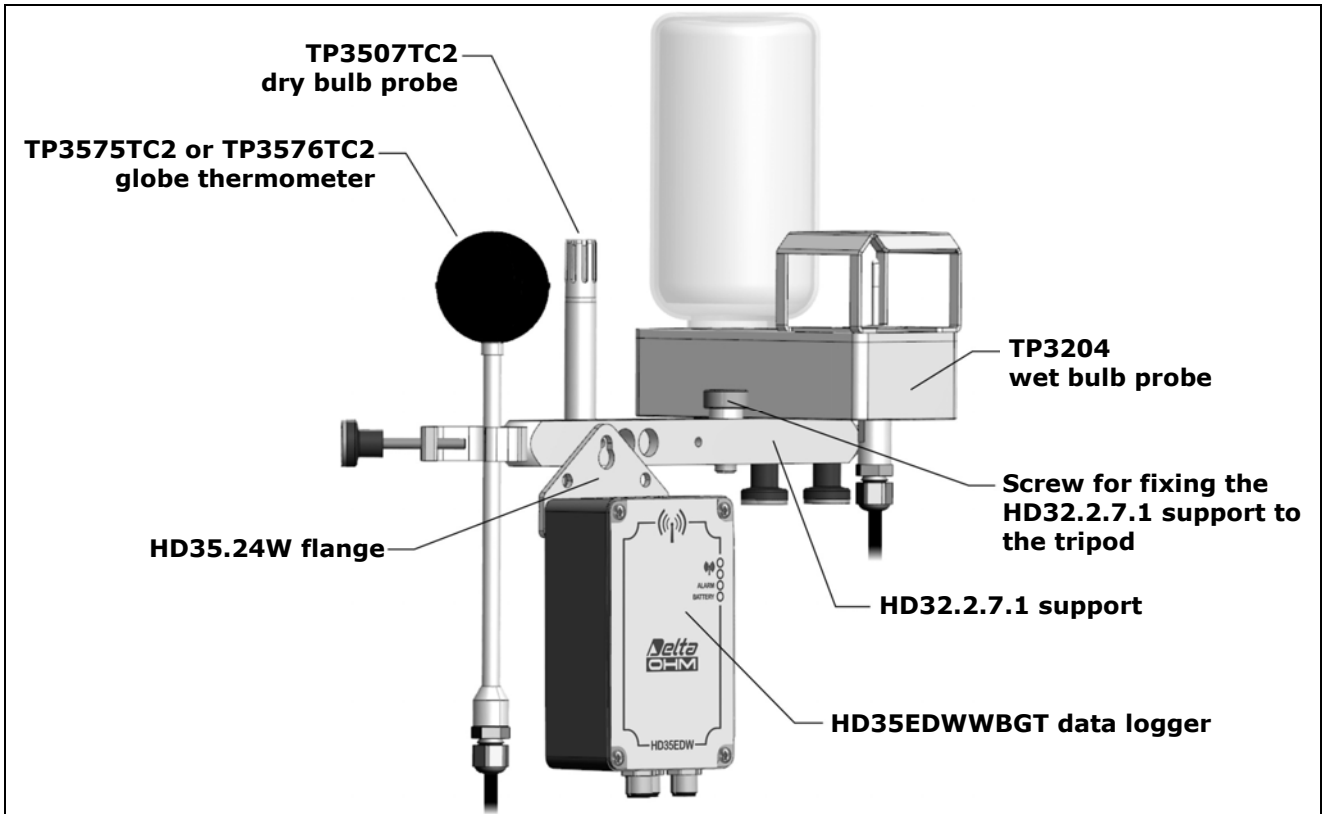

Installation with HD32.4.17 bracket:

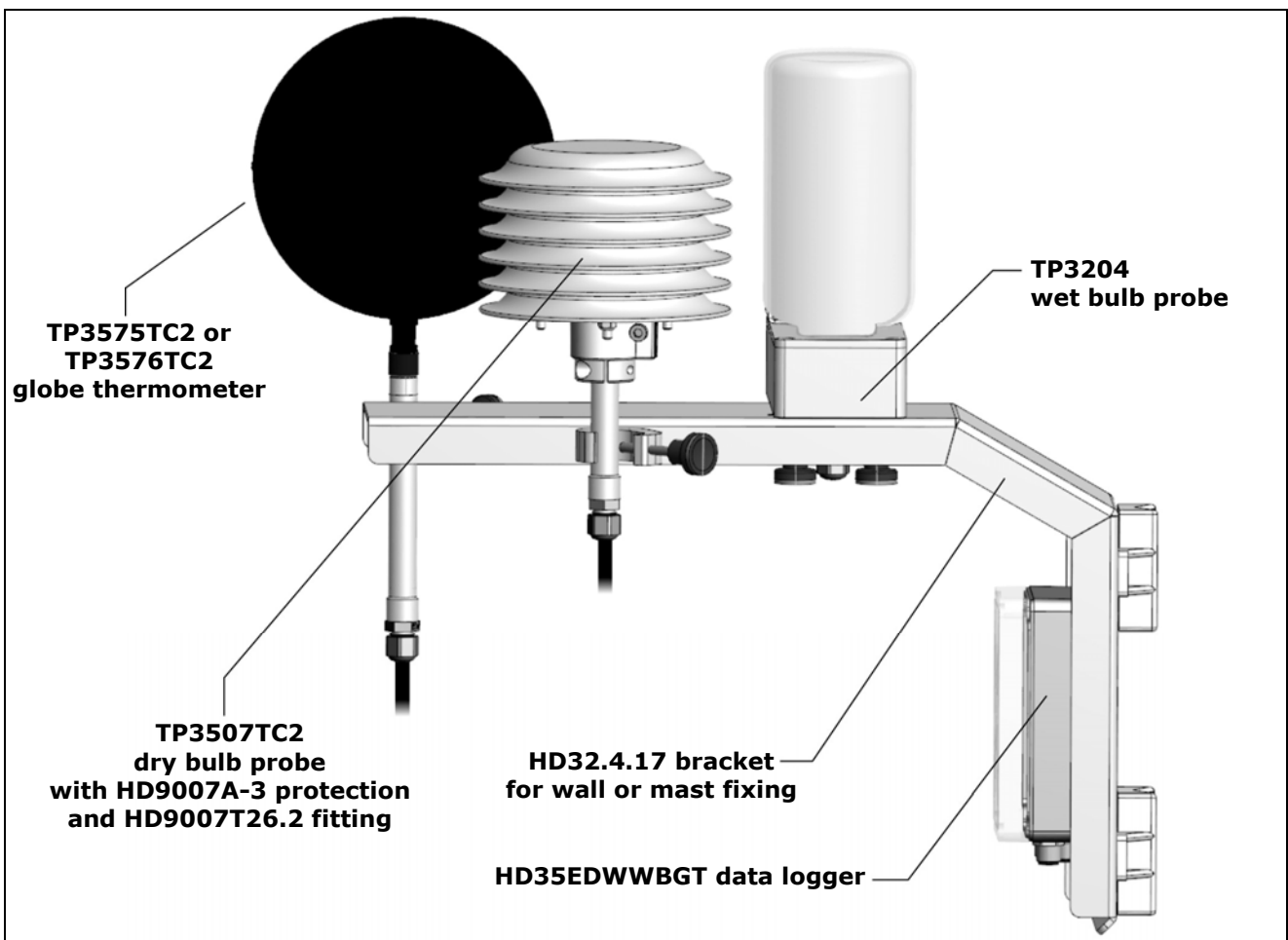

Measurements not according to ISO 7243:

The wet bulb temperature probe and the dry bulb temperature probe can be replaced (**on request when ordering the data logger**) by the **HP3517ETC2...** combined temperature and relative humidity probe (**Pt100** temperature sensor). **The WBGT index measurement with combined temperature and relative humidity probe is not according to ISO 7243.**

The outdoor installation of the HP3517ETC2... probe requires HD9007A-3 protection against solar radiations.

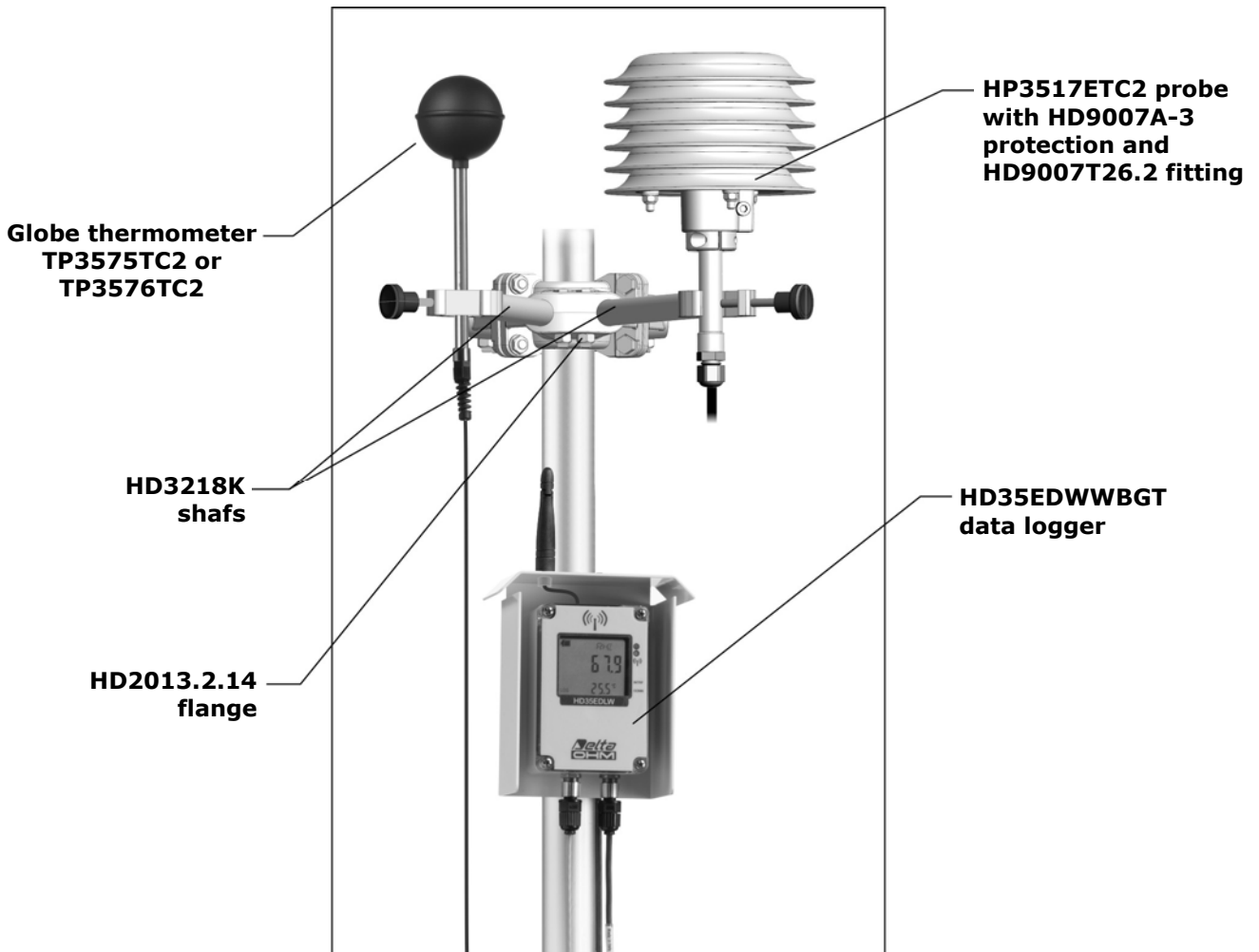

8.13 VOLATILE ORGANIC COMPOUNDS (VOC) MONITORING (HD35ED[G]1NB...V MODEL)

Volatile organic compounds (VOC) are polluting chemicals that evaporate easily at ambient temperature and pressure. An excessive concentration of these substances in indoor environments reduces the quality of the air, causing discomfort or, in the most serious cases, alterations in the state of health (irritation, breathing difficulties, etc.) in the people present in the environment. The detection of volatile organic compounds is therefore a factor of primary importance in determining the quality of indoor air.

There are many sources of VOC pollution in indoor environments, for example:

- glues, adhesives, solvents, paints;
- cosmetic products, deodorants;
- cleaning products;
- heating devices;
- printers, photocopiers;
- cigarette smoke;
- building materials;
- furnishings (furniture, coatings);
- the "occupants" themselves (breathing, body surface).

The VOC measurement provided by HD35ED[G]1NB...V is not an absolute concentration, but it is a measurement:

- relative (compared to the average situation of the monitored environment);
- qualitative (index of better or worse than the average situation).

The sensor must therefore "adapt" to the environment to be monitored, so that the average pollution state (background value) of the environment can be determined. For this to happen, **it is necessary to leave the instrument operating in the environment to be monitored for at least 12 hours.**

After the time of adaptation to the environment, the state of VOC pollution is expressed as an index variable from 1 to 500 (dimensionless). The value 100 corresponds to the background value of the environment. Values below 100 indicate that VOC pollution is improving; values above 100 indicate that VOC pollution is worsening compared to the determined background value.

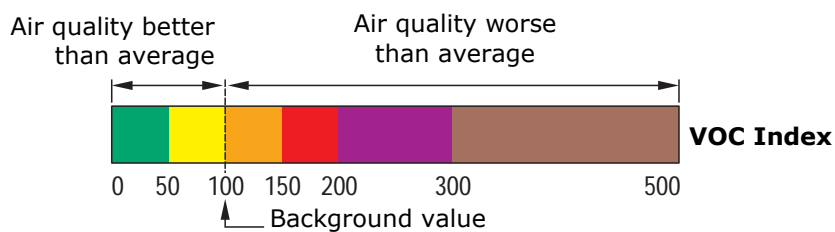

VOC Index	Air quality
VOC Index < 50	Much better than average
50 < VOC Index < 100	Slightly better than average
100 < VOC Index < 150	Slightly worse than average
150 < VOC Index < 200	Somewhat worse than average
200 < VOC Index < 300	Much worse than average
300 < VOC Index < 500	Bad compared to average

The VOC index value is an average referring to the last 24 hours of monitoring.

Not being an absolute indication, the VOC measurement is not suitable for comparing different environments, because environments with a very different degree of pollution could generate similar values of the VOC index, being the index based on the background value of the environment.

8.14 DATA LOGGERS TECHNICAL SPECIFICATIONS

Transmission frequency	868 MHz, 902-928 MHz or 915.9-929.7 MHz according to the model
Antenna	Internal. Only outdoor models (except HD35EDWPM...): on request, fixed or with 3 m cable external antenna.
Transmission range	In open field (it can decrease in the presence of obstacles or adverse weather conditions): 180 m (E, U) towards base unit HD35APD. 300 m (E, J)/ 180 m (U) with internal antenna towards base unit (except HD35APD) and repeaters. > 500 m (E, J, U) with external antenna towards base unit (except HD35APD) and repeaters.
Measuring interval (*)	1, 2, 5, 10, 15, 30 s / 1, 2, 5, 10, 15, 30, 60 min
Logging and transmission interval (*)	1, 2, 5, 10, 15, 30 s / 1, 2, 5, 10, 15, 30, 60 min
Alarm	Acoustic by means of the internal buzzer
Power supply	Li-SOCl ₂ not rechargeable battery, except the following models: HD35ED[1N]4r1Z: 3 x AA alkaline batteries HD35ED1NB[2]V: external power supply via USB + 3 x AA alkaline back-up batteries HD35EDWHE: 7...28 Vdc (< 10 mA) external power supply HD35EDW-MB: 7...30 Vdc (< 10 mA) external power supply HD35EDWPM[B]: 7...30 Vdc (25 mA @ 24 Vdc) external power supply HD35EDWPM[B]-USB: external power supply via USB HD35EDW1NB[2]TV: 7...30 Vdc (< 5 mA average, 300 mA approx. peak) external power supply
Battery life (without repeaters, direct communication with HD35AP...)	2 years typical with 5 s measuring interval and 30 s log interval, except: HD35EDWH and HD35EDWK/4: 4 years typical with 10 s measuring interval and 30 s log interval HD35EDH, HD35EDW7P/...TC, HD35EDW14bNTC, HD35EDW14b7PTC and HD35EDWWBGT: 2 years typical with 10 s measuring interval and 30 s log interval HD35ED[1N]4r1/2/3/4: 2 years typical with 30 s measuring and log interval HD35ED[1N]4r1ZTV: 1,5 years typical with 30 s measuring and log interval HD35ED1[4b]NB: 1,5 years typical with 2 min measuring and log interval
Display	Optional, custom or graphic depending on the model HD35EDWPM... is not available with display
Operating conditions	-20...+70 °C (-10...+70 °C for HD35ED1[4b]NB..., -20...+60 °C for HD35EDW1NB...) 0...85 %RH not condensing for indoor models 0...100 %RH for outdoor models (0...95 %RH for HD35EDWPM...)
Protection Degree	IP 50 for indoor models (except HD35ED1[4b]NB...) IP 67 for outdoor models (except HD35EDW1NB... and HD35EDWPM...) IP 65 for HD35EDW1NB... HD35EDWPM... is equipped with a rain-proof and UV resistant inlet air filter – IP 53
Weight	200 g approx. for indoor models 250 g approx. for outdoor models
Housing	ABS for indoor models Polycarbonate for outdoor models

(*) Models measuring several quantities may have a minimum interval exceeding 1 second.

Memory capacity and stored quantities

Model	Samples number (**)	Min. log interval	Stored quantities (*)
Indoor models			
HD35ED7P/xTC	from 42,000 to 68,000 depending on channels nr.	1 s (1 ch.) 5 s (3 ch.)	T
HD35EDN/xTC	from 42,000 to 68,000 depending on channels nr.	1 s	T
HD35EDNTV	68,000	1 s	T
HD35ED1NTC/TV[I]	24,000	1 s	T, RH, T _D , T _w , AH, MR, PVP
HD35ED17PTC	24,000	1 s	T, RH, T _D , T _w , AH, MR, PVP
HD35ED14bNTV[I]	22,000	2 s	T, RH, T _D , T _w , AH, MR, PVP, P _{ATM}
HD35ED1N4r...TV	22,000	1 s	T, RH, T _D , T _w , AH, MR, PVP, ΔP
HD35ED4r...	68,000	1 s	ΔP
HD35ED1NI[2]T[C]V	44,000	1 s	T, RH, T _D , T _w , AH, MR, PVP, I
HD35ED1NB	44,000	10 s	T, RH, T _D , T _w , AH, MR, PVP, CO ₂
HD35ED14bNB	36,000	10 s	T, RH, T _D , T _w , AH, MR, PVP, P _{ATM} , CO ₂
HD35ED1NB[2]V	from 44,000 to 120,000	1 s	T, RH, T _D , T _w , AH, P _{ATM} , CO ₂ , VOC
HD35EDH	from 36,000 to 68,000	5 s (***)	
Outdoor models			
HD35EDW7P/xTC	from 42,000 to 68,000 depending on channels nr.	1 s (1 ch.) 5 s (3 ch.)	T
HD35EDWN/xTC	from 42,000 to 68,000 depending on channels nr.	1 s	T
HD35EDWNTV	68,000	1 s	T
HD35EDWK/4TC	from 36,000 to 68,000	5 s (***)	T
HD35EDW1NTC/TV[I]	24,000	1 s	T, RH, T _D , T _w , AH, MR, PVP
HD35EDW17PTC	24,000	1 s	T, RH, T _D , T _w , AH, MR, PVP
HD35EDW14bNTC	22,000	2 s	T, RH, T _D , T _w , AH, MR, PVP, P _{ATM}
HD35EDW14b7PTC	22,000	2 s	T, RH, T _D , T _w , AH, MR, PVP, P _{ATM}
HD35EDWRTC	42,000	1 s	R, D _R , mV
HD35EDWPTC	36,000	1 s	P, D _P , I _P
HD35EDWDPTC	28,000	1 s	F _L , P _{REL} , P, D _P , I _P
HD35EDW1NLTC	22,000	1 s	T, RH, T _D , T _w , AH, MR, PVP, H _{LEAF}
HD35EDWS...TC	from 26,000 to 52,000 depending on channels nr.	1 s	T, VWC
HD35EDW1NB[2]TV	30,000	1 s (***)	T, RH, T _D , AH, CO ₂
HD35EDWPM	da 34,000 a 60,000	1 s	PM1.0, PM2.5, PM10
HD35EDWPMB	da 26,000 a 60,000	1 s	PM1.0, PM2.5, PM10, CO ₂ , P _{ATM}
HD35EDWWBGT	22,000	2 s	T, T _{NW} , T _G , RH, T _D , WBGT
HD35EDWH	from 28,000 to 58,000	5 s (***)	
HD35EDW-MB	from 14,000 to 52,000	1 s	

(*) List of the quantities:

AH: absolute humidity	P_{REL}: relative pressure
CO₂: carbon dioxide	PM_{xx}: particulate matter with a diameter of less than xx μm
D_P: daily rainfall quantity	PVP: partial vapour pressure
D_R: daily solar radiation (Wh/m ²)	R: solar radiation (pyranometer)
F_L: fluid level	RH: relative humidity
H_{LEAF}: leaf wetness	T: temperature
I: illuminance	T_D: dew point
I_P: rainfall rate (mm/h)	T_G: globe thermometer temperature
MR: mixing ratio	T_{NW}: natural ventilation wet bulb temperature
mV: pyranometer output in mV	T_w: wet bulb temperature
P: rainfall quantity	VOC: volatile organic compound
ΔP: differential pressure	VWC: soil volumetric water content
P_{ATM}: atmospheric pressure	WBGT: WBGT index

(**) The number of samples depends on the number of stored quantities. A sample consists of all the quantities measured and/or calculated enabled for storing.

Dry bulb temperature HD35EDWWBGT	
Sensor	Pt100
Measuring range	-40...+100 °C
Resolution	0.1 °C
Accuracy	1/3 DIN (TP3507TC2 probe)
Stability	0.1 °C/year
Wet bulb temperature HD35EDWWBGT	
Sensor	Pt100
Measuring range	+4...+80 °C
Resolution	0.1 °C
Accuracy	Class A (TP3501TC2 and TP3204 probes)
Stability	0.1 °C/year
Probe reservoir capacity	15 cc (TP3501TC2) / 500 cc (TP3204)
Probe reservoir autonomy	96 hours @ 50 %RH and 23 °C (TP3501TC2) 15 days @ 40 °C (TP3204)
Globe-thermometer temperature HD35EDWWBGT	
Sensor	Pt100
Measuring range	-30...+120 °C
Resolution	0.1 °C
Accuracy	1/3 DIN (TP3575TC2 and TP3576TC2 probes)
Stability	0.1 °C/year
Relative Humidity HD35ED[W]1[4b]N...TC/TV	
Sensor	Capacitive
Measuring range	0...100%
Resolution	0.1%
Accuracy	± 1.8% (0...85%) / ± 2.5% (85...100%) @ T=15...35 °C ± (2 + 1.5% measure)% @ T=remaining range
Sensor operating temperature	-20...+80 °C TV versions and TC versions with HP3517TC... probe -40...+105 °C TC versions with HP3517WTC... probe -40...+150 °C TC versions with HP3517ETC... probe
Response time	T ₉₀ < 20 s (air speed = 2 m/s without filter)
Stability	1%/year (in the whole temperature and RH range)
Relative humidity HD35ED[W]1[4b]NTVI, HD35ED1[4b]NB[V]	
Sensor	Capacitive
Measuring range	0...100%
Resolution	0.1%
Accuracy	± 2.5% (0..85%) / ± 3.5% (85...100%) @ T=23 °C
Temperature drift	0.05%/K (0...60 °C)
Sensor operating temperature	-40...+105 °C (R.H. max=[100-2*(T-80)] @ T=80...105 °C)
Response time	T ₆₃ < 4 s (air speed = 2 m/s, without filter)
Stability	< 1%/year (@ 23 °C and 30...70 %RH)

Atmospheric Pressure					
Sensor	Piezoresistive				
Measuring range	300...1100 hPa (except HD35ED1NB[2]V and HD35EDWPMB) 700...1100 hPa (only HD35ED1NB[2]V and HD35EDWPMB)				
Resolution	0.1 hPa				
Accuracy	± 0.5 hPa (700...1100 hPa) @ 20 °C ± 1 hPa (500...1100 hPa) / ± 1.5 hPa (300...500 hPa) @ T=(0...60 °C) Only HD35ED1NB[2]V and HD35EDWPMB: ± 2 hPa @ T=25 °C & RH=20...80% / Drift ± 0.015 hPa/°C				
Stability	±1 hPa/year				
Differential Pressure					
Sensor	Piezoresistive				
Measuring range	According to the model:				
	4r1Z ±100 Pa	4r1 ±2.5 hPa	4r2 ±10 hPa	4r3 ±100 hPa	4r4 ±2000 hPa
Resolution	0.1 Pa	0.001 hPa	0.005 hPa	0.05 hPa	1 hPa
Accuracy	4r1Z: ± (0.8% of measure + 0.5) Pa @ 0...50 °C 4r1/2/3/4: ± 1% f.s				
Pressure inputs	Ø 5.5 mm				
Carbon Dioxide (CO₂)					
Sensor	Non-dispersive infrared rays (NDIR)				
Measuring range	B: 0...5,000 ppm / B2: 0...10,000 ppm				
Resolution	1 ppm				
Accuracy	B: ± (50 ppm + 3% of measurement) @ 25 °C and 1013 hPa B2: ± (100 ppm + 5% of measurement) @ 25 °C and 1013 hPa				
Sensor operating conditions	HD35ED1[4b]NB: 0...50 °C / 0...95%RH non condensing / 950...1100 hPa HD35ED1NB[2]V, HD35EDWPMB e HD35EDW1NB[2]: -20...60 °C / 0...95%RH non condensing / 700...1100 hPa				
Response time	T ₉₀ < 120 s (air speed= 2 m/s)				
Calibration interval	> 5 years (recommended under normal operating conditions)				
Volatile Organic Compounds (VOC)					
Sensor	Metal-Oxide film				
Measuring range	1...500 (dimensionless index)				
Resolution	1				
Accuracy	Relative qualitative measurement (see page 60)				
Particulate Matter (PM)					
Measuring principle	Laser scattering				
Pollutants detected	PM1.0, PM2.5, PM10				
Measuring range	0...1000 µg/m ³ (for each pollutant)				
Resolution	0.1 µg/m ³				
Linearity error	< 5%				
Repeatability	< 3%				
Warm up time	< 15 s				
Temperature drift	< 0.01 µg/m ³ /°C				

Rainfall quantity (*)	
Sensor	Tipping bucket with NC or NO configurable contact
Resolution	Configurable 0.1 – 0.2 – 0.5 mm/tipping
Solar radiation (*)	
Sensor	Thermopile
Measuring range	0...2000 W/m ²
Resolution	1 W/m ²
Sensitivity	Configurable in mV/(kW m ⁻²)

(*) Measurement characteristics not reported depend on the external sensor connected, please refer to the data sheet of the chosen external sensor.

Illuminance	
Sensor	Photodiode
Measuring range	I: 0...20,000 lux I2: 0...200,000 lux
Resolution	I: 1 lux (0...2,000 lux), 10 lux (>2,000 lux) I2: 10 lux (0...20,000 lux), 100 lux (>20,000 lux)
Spectral range	In accordance with standard photopic curve V(λ)
Spectral response	See graph 1
α (temperature coefficient) $f_6(T)$	<0.05% K
Calibration uncertainty	<4%
f_1 (accordance with photopic response V(λ))	<6%
f_2 (response as cosine law)	<3%
f_3 (linearity)	<1%
f_4 (instrument reading error)	<0.5%
f_5 (fatigue)	<0.5%
Class	B
One year drift	<1%
Operating temperature	0...50 °C
Reference standard	CIE n°69 – UNI 11142

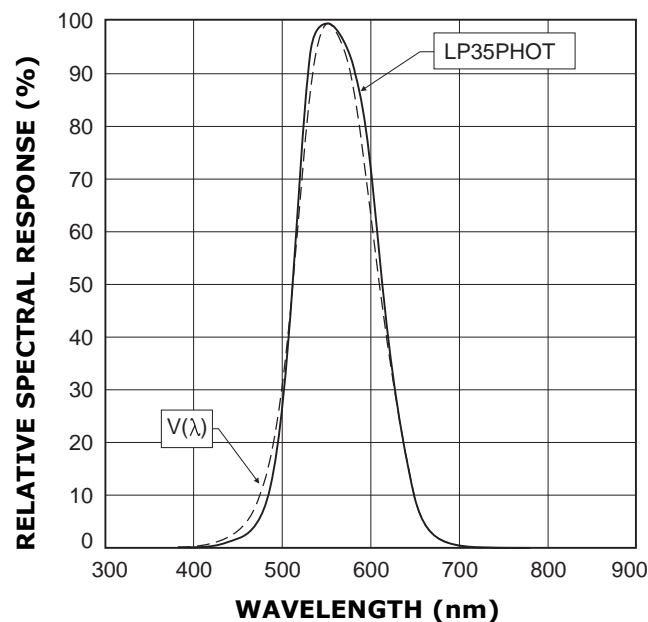

Voltage input	
Input range	0...50 mV, -50...50 mV (only HD35EDWH), 0...1 V, 0...10 V (only HD35EDWH)
Input Resistance	100 M Ω
Resolution	16 bit
Accuracy	$\pm 0.01\%$ f.s.
Inputs for counting the switchings of a voltage-free contact	
Switching frequency	50 Hz max.
Hold Time	10 ms min.
Potentiometer input	
Potentiometer	Typically 10 k Ω
Resolution	16 bit
Accuracy	$\pm 0.01\%$ f.s.

9 HD35ED-ALM REMOTE ALARM DEVICE

9.1 DESCRIPTION

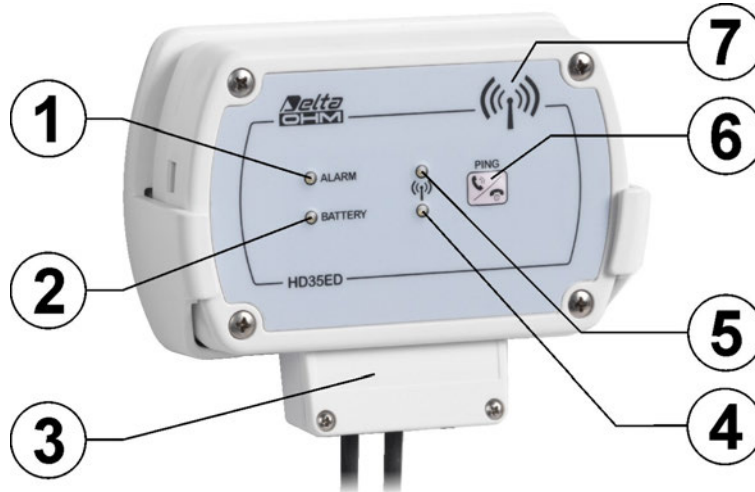

1. ALARM LED: red color, it blinks to signal alarm conditions.
2. BATTERY LED: green color, it indicates the internal battery charge level. As the battery is running low, the LED blinks with a lower frequency (once every 5 s = battery is charged, once every 10 s = 50% battery charge, once every 15 s = battery is almost discharged).
3. Relay outputs. The connection terminals are protected by a cover.
4. Green RF LED: it blinks if RF transmission was successful.
5. Red RF LED: it blinks to indicate that RF transmission has failed
6. Connection / PING (for testing RF) button.
7. Internal RF antenna.

9.2 CONNECTION

Two bistable relays with potential-free contact are available. In order for relays to be activated in case of an alarm, alarm conditions should be associated to relays activation through the HD35AP-S software (see section **Alarm settings** in the software instructions). Contacts arrangement is shown in the following figure.

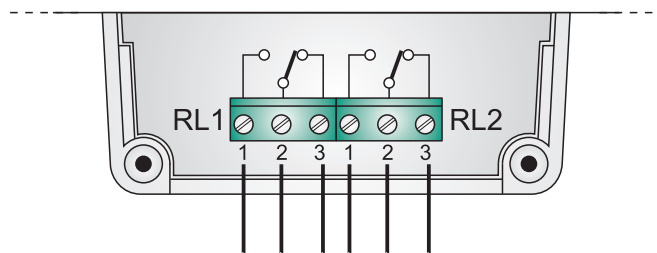

Fig. 9.2.1: relays in HD35ED-ALM alarm device

9.3 CONNECTION TO THE WIRELESS NETWORK

The device can be connected and disconnected to/from the wireless network by **pressing for 5 seconds** the connection button on the front panel.

If the device is disconnected, by pressing the connection button for 5 seconds the buzzer emits a beep and the green LED activates for one second to indicate the start of the connection procedure. If the device belongs to a wireless network and the base unit is reachable, once connected, the buzzer emits a second beep and the green RF LED will blink during data transmission. If the device doesn't belong to a wireless network or the base unit cannot be reached, the second beep of the buzzer is not emitted and the red RF LED will blink.

If the device is connected, by pressing the connection button for 5 seconds the buzzer emits a beep, the red RF LED activates for one second and the device is disconnected.

PING function:

In the devices connected to a wireless network it is possible to check if the base unit can be reached by briefly pressing the connection button: if the green RF LED is blinking, it means that the base unit is reachable, otherwise it will be the red RF LED to blink.

9.4 ALARM DEVICE TECHNICAL SPECIFICATIONS

Transmission Frequency	868 MHz, 902-928 MHz or 915.9-929.7 MHz according to the model
Antenna	Internal
Transmission range	In open field (it can decrease in the presence of obstacles or adverse weather conditions): 180 m (E, U) towards base unit HD35APD. 300 m (E, J)/ 180 m (U) towards base unit (except HD35APD...) and repeaters.
Relays	2 bistable relays with potential-free contact Contact: max 1A @ 30Vdc resistive load
Buzzer	Sounds cyclically when an alarm condition occurs: 1 single beep indicates that relay 1 is active 2 beeps in rapid succession indicate that relay 2 is active 3 beeps in rapid succession indicate that both relays are active
Power supply	Li-SOCl ₂ not rechargeable battery
Battery life	1 year in typical operating conditions The effective life depends on how often the alarm condition is generated
Operating conditions	-10...+70 °C / 0...85 %RH non condensing
Weight	200 g approx.
Housing	ABS
Installation	Wall mount (supplied) for removable installation or flanges (optional) for fixed installation

10 DIMENSIONS

The following figures show the dimensions of the instruments in mm.

INDOOR BASE UNITS AND REPEATER:

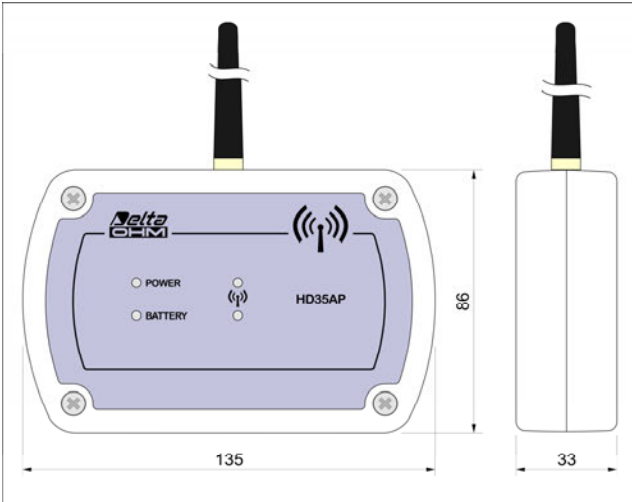

HD35APW / HD35APxG / HD35APS / HD35RE
The position of the antenna depends on model

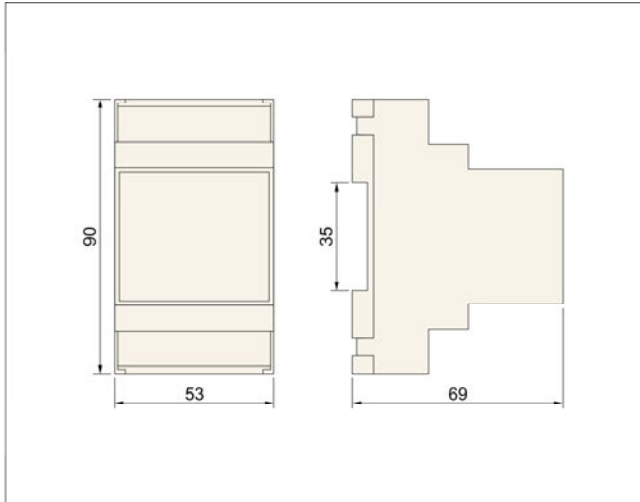

HD35APR

INDOOR DATA LOGGERS AND ALARM MODULE:

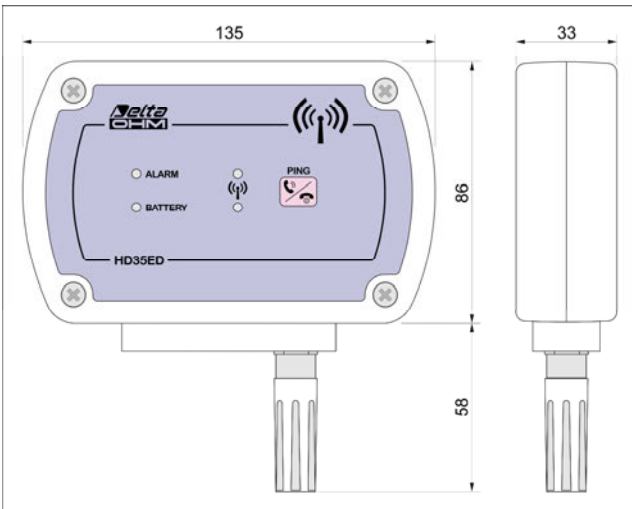

HD35ED...TV

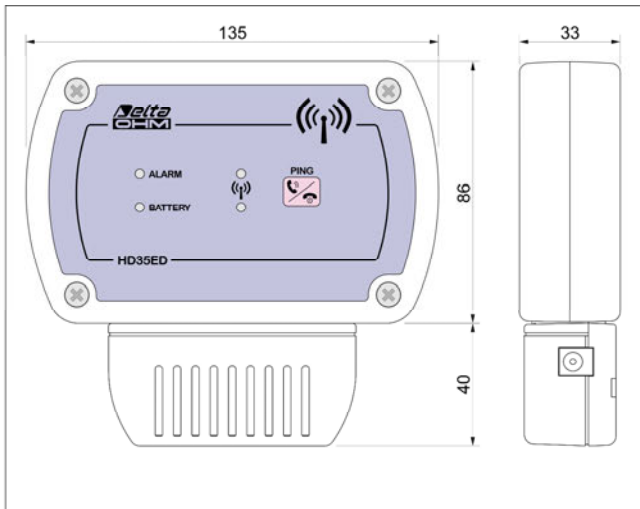

HD35ED1NB[V]

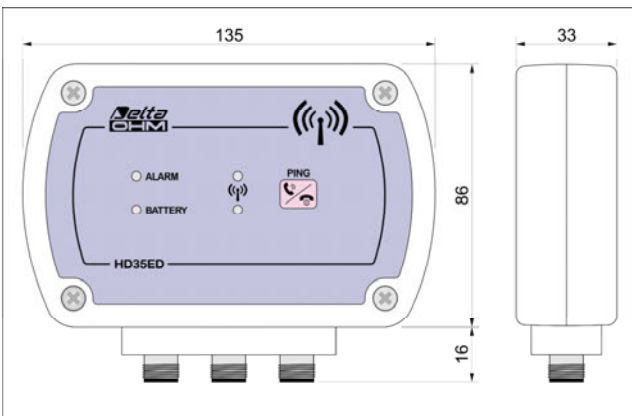

HD35ED...TC

The numbers of connectors depends on model

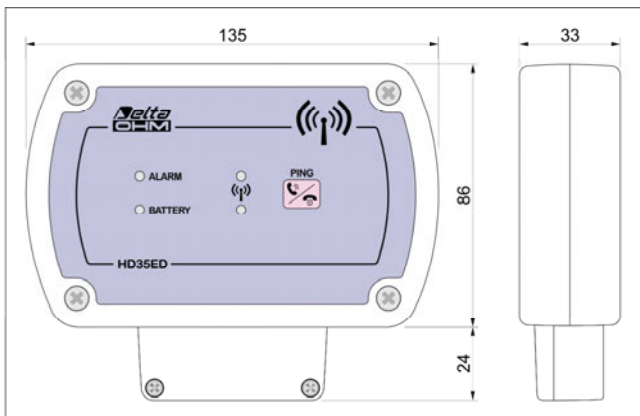

HD35EDH / HD35ED-ALM

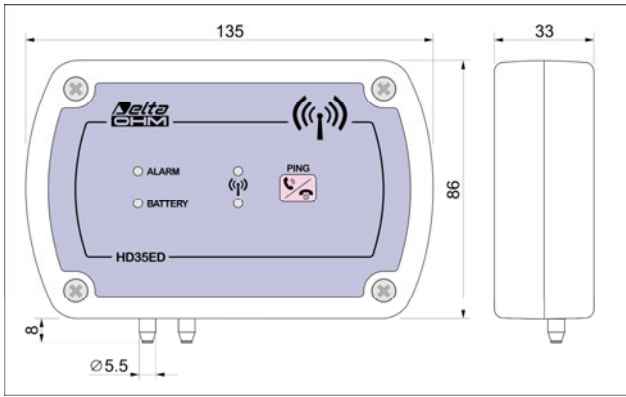

HD35ED4r...

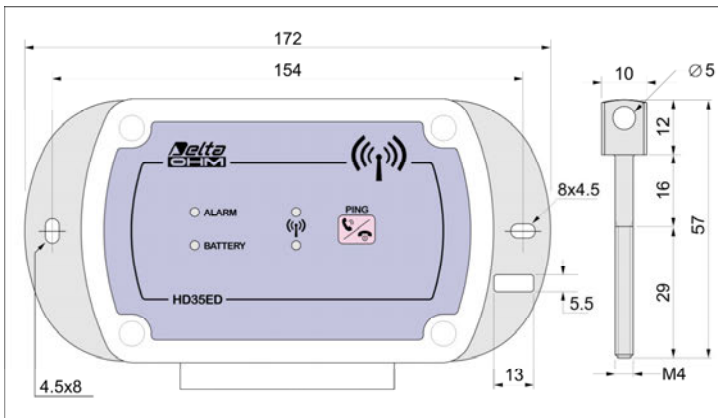

Flanges for fixed installation (HD35.11K)

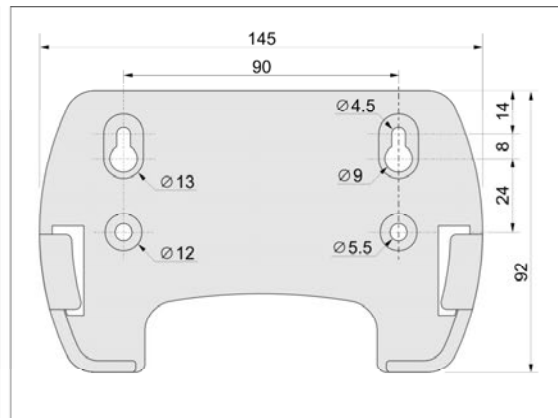

Support for removable installation

OUTDOOR DATA LOGGERS AND REPEATER:

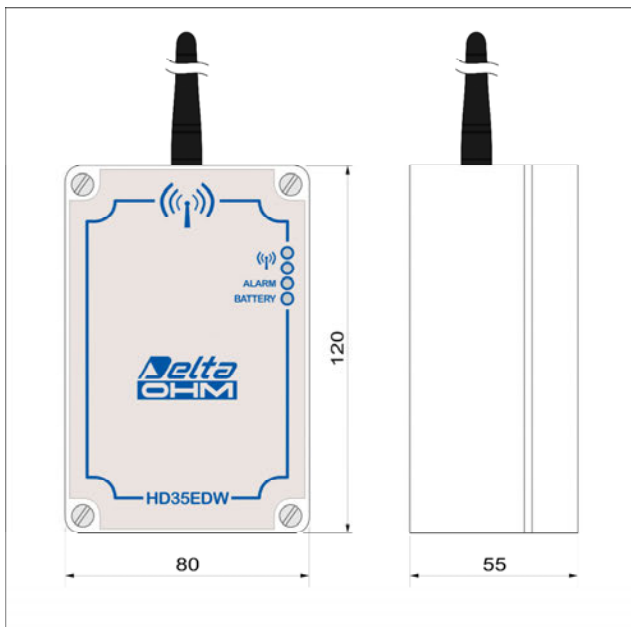

HD35REW

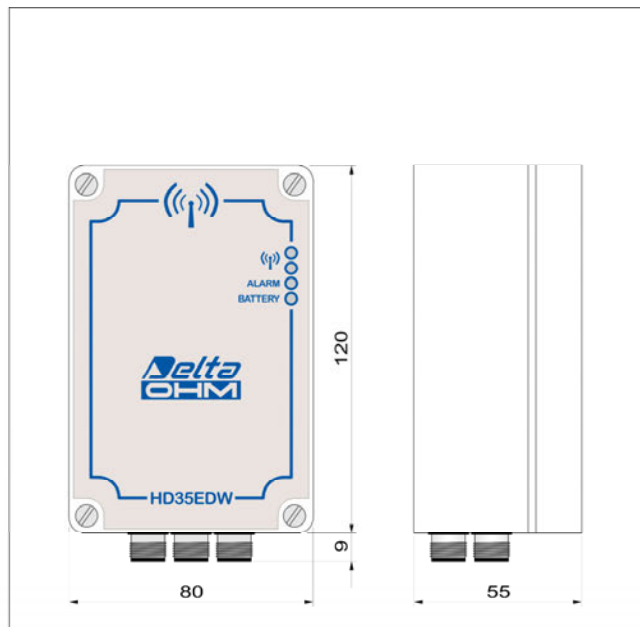

HD35EDW...TC

The numbers of connectors depends on model

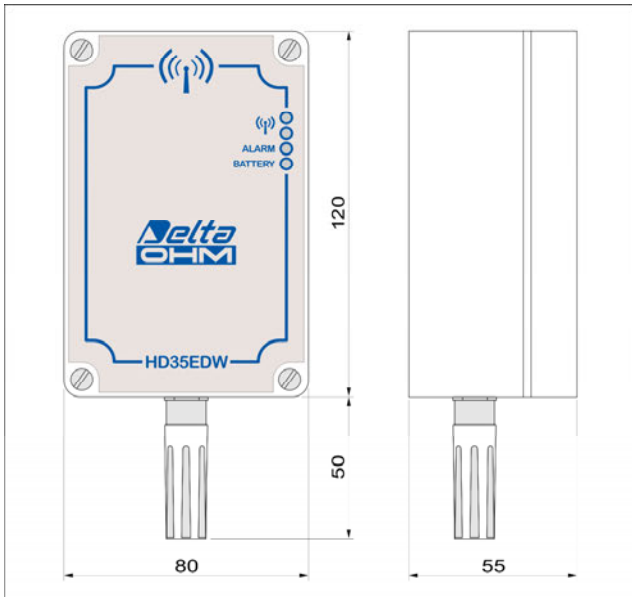

HD35EDW...TV

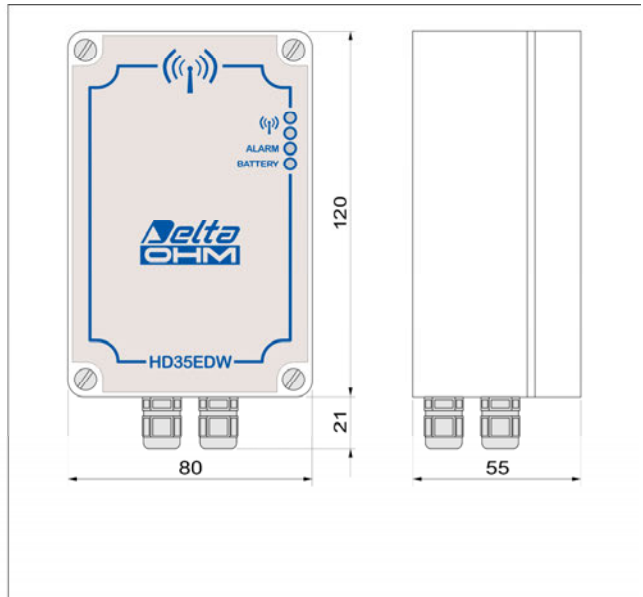

HD35EDWH / HD35EDW-MB

The numbers of cable glands depends on model

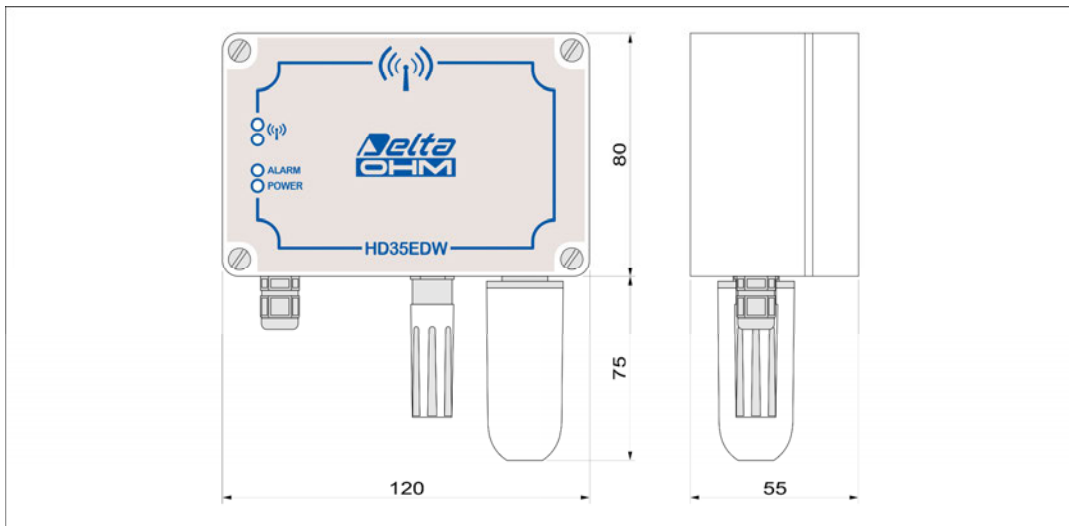

HD35EDW1NBTV

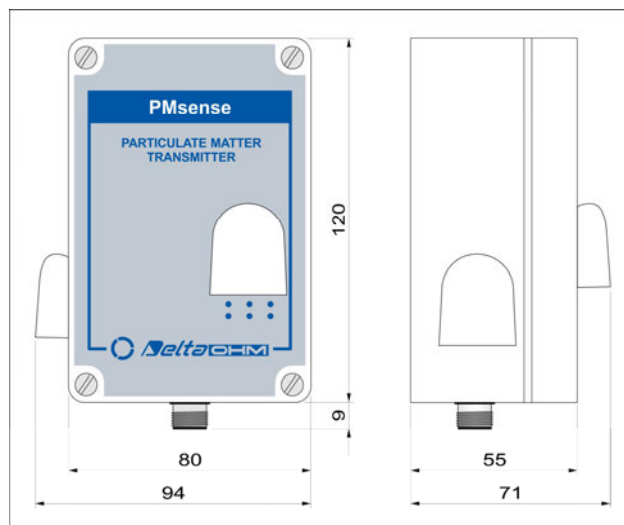

HD35EDWPM[B]

This model is supplied with HD35.24C flange

11 STORAGE OF INSTRUMENTS

Instruments storage conditions:

- Temperature: -40...+70 °C.
- Humidity: less than 90 %RH no condensation.
- In storage, avoid places where:
 - humidity is high;
 - instruments are exposed to direct sun radiation;
 - instruments are exposed to a high temperature source;
 - high vibration levels are present;
 - there are vapor, salt and/or corrosive gas.

12 SAFETY INSTRUCTIONS

General safety instructions

The instruments have been manufactured and tested in compliance with the safety standard EN61010-1:2010 "Safety requirements for electrical equipment for measurement, control and laboratory use" and left the factory in a safe and secure technical condition.

The instruments proper operation and operating safety can be ensured only if all standard safety measures as well as the specific measures described in this manual are followed.

The instruments proper operation and operating safety can be ensured only in the climatic conditions specified in this manual.

Do not use the instruments in places where there are:

- Rapid ambient temperature variations that may cause condensation.
- Corrosive or flammable gases.
- Direct vibrations or shocks to the instrument.
- High-intensity electromagnetic fields, static electricity.

If the instruments are moved from a cold place to a hot one, or vice versa, condensation formation can cause their malfunction. In this case, you will have to wait for the instruments temperature to reach ambient temperature before turning the instruments on.

User obligations

The instruments operator shall follow the directives and regulations below that refer to the treatment of dangerous materials:

- EEC directives on workplace safety
- National law regulations on workplace safety
- Accident prevention regulations

13 PROBES AND ACCESSORIES ORDERING CODES

The devices are supplied with battery (if required by the model), HD52.03 wall mount support (only indoor models) and HD35AP-S software (downloadable from Delta OHM website). External probes, connection cables, external power supplies, other fixing accessories and the HD35AP-CFR21 advanced software (for the management of the system in accordance with the FDA 21 CFR part 11 recommendations) have to be ordered separately.

TEMPERATURE AND RELATIVE HUMIDITY COMBINED PROBES

HP3517... Temperature and relative humidity combined probe. R.H. sensor measuring range: 0...100%.
 Temperature sensor: NTC (HP3517[W]TC...), Pt100 (HP3517ETC...).
 Temperature measuring range: -40...+105 °C (HP3517[W]TC...), -40...+150 °C (HP3517ETC...).
 R.H. sensor operating temperature: -20...+80 °C (HP3517TC...), -40...+105 °C (HP3517WTC...), -40...+150 °C (HP3517ETC...).
 Diameter 14 mm. Cable length 2, 5 or 10 m standard. 4-pole (HP3517[W]TC...) or 8-pole (HP3517ETC...) M12 connector.

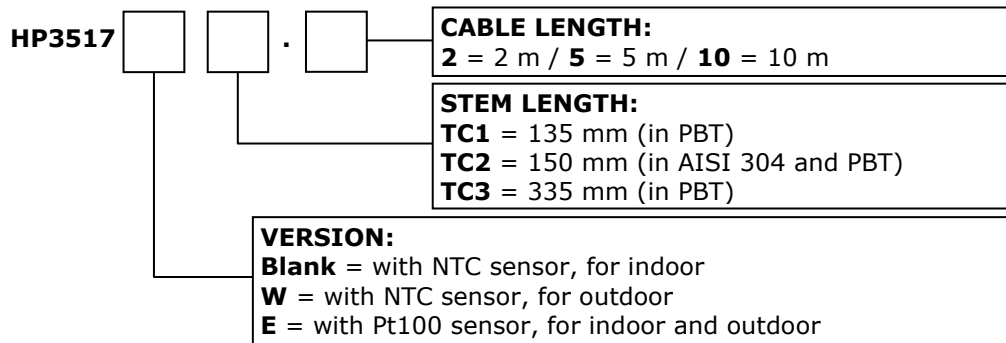

The outdoor installation of the HP3517... probe requires HD9007A-1 or HD9007A-2 protection against solar radiations. The replacement of the HP3517... probe requires recalibration of the instrument in line with the new probe.

- HD9007A-1** 12-ring protection against solar radiations. Includes support bracket.
- HD9007A-2** 16-ring protection against solar radiations. Includes support bracket.
- HD9007T26.2** Adapter for Ø 14 mm probes for protections against solar radiations HD9007A-1 and HD9007A-2.

TEMPERATURE PROBES

Note: the Pt100/Pt1000 probes (4-pole M12 connector) cannot be connected to the input for HP3517ETC... temperature and relative humidity combined probes (8-pole M12 connector).

TP350N... NTC 10 KΩ environmental temperature probe. Operating temperature: -40...+105 °C. 14 mm diameter. Cable length 2, 5 or 10 m standard. 4-pole M12 connector.

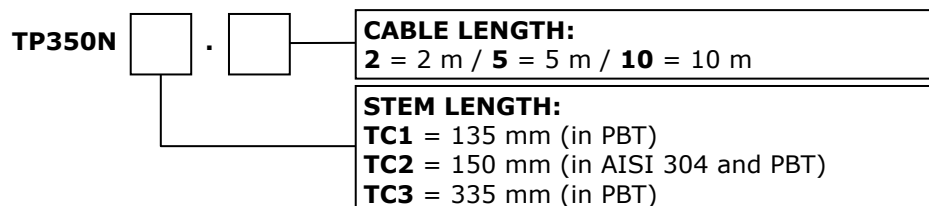

The outdoor installation of the TP350N... probe requires HD9007A-1 or HD9007A-2 protection against solar radiations.

TP35N1... **NTC** 10 K Ω temperature probe. Operating temperature: -40...+105 °C. \varnothing 5 x 40 mm AISI 316 stainless steel tube. Cable length 3, 5 or 10 m standard. Cable ending with free wires or 4-pole M12 connector.

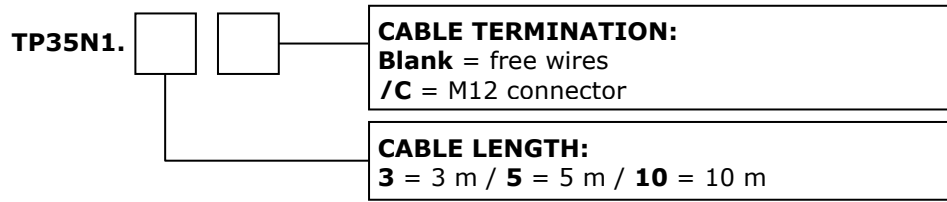

TP35.1... 4-wire 1/3 DIN **Pt1000** temperature probe. Operating temperature: -50...+105 °C. \varnothing 5 x 40 mm AISI 316 stainless steel tube. Cable length 3, 5 or 10 m standard. Cable ending with free wires or 4-pole M12 connector.

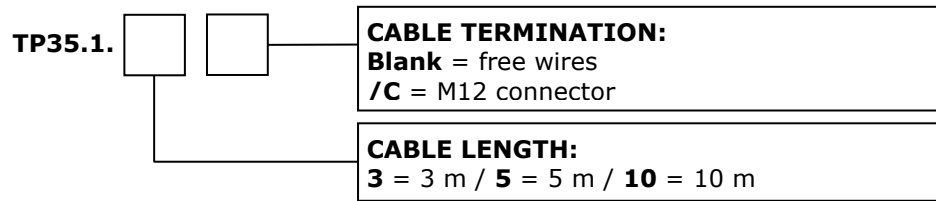

TP35.2... 4-wire 1/3 DIN **Pt1000** temperature probe. Operating temperature: -40...+105 °C. \varnothing 5 x 20 mm thermoplastic rubber tube. Cable length 3 or 5 m standard. Cable ending with free wires or 4-pole M12 connector. Suitable for use with chemically aggressive solutions as well.

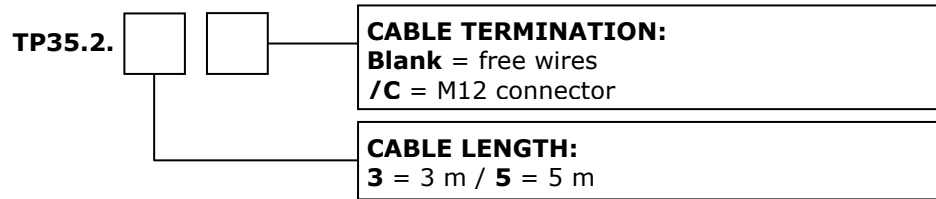

TP35.4... 4-wire 1/3 DIN **Pt100** temperature probe. Operating temperature: -50...+105 °C. \varnothing 6 x 50 mm AISI 316 stainless steel tube. Cable length 3 or 5 m standard. Cable ending with free wires or 4-pole M12 connector.

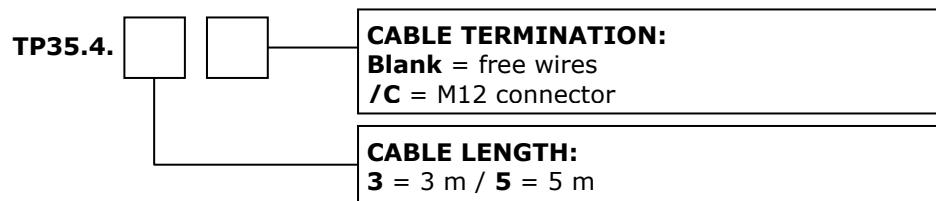

TP35878.3 Contact temperature probe for solar panel. 3-wire class B **Pt100**. Operating temperature: -40...+150 °C. Adhesive aluminum plate 10 x 30 x 5 mm. TPE isolated cable. Cable length 3 m. Cable ending with 4-pole M12 connector.

TP35878ISS... Contact temperature probe for solar panel. 4-wire 1/3 DIN **Pt100**. Operating temperature: -40...+85 °C. Aluminum disk \varnothing 30 x 7.5 mm. Cable length 5 m (TP35878ISS.5) or 10 m (TP35878ISS.10). Cable ending with 4-pole M12 connector.

TP35K6.5 **K-thermocouple** temperature probe. Isolated junction. Class 1 according to IEC 60584-1. Operating temperature: -50...+750 °C. \varnothing 3 x 150 mm AISI 316 stainless steel tube. Cable length 5 m. Cable ending with free wires.

PROBES FOR WBGT MEASUREMENT

- TP3501TC2** Natural ventilation wet bulb probe. Pt100 sensor. Probe stem probe: Ø 14 mm, length 110 mm. 2 m cable with 4-pole M12 connector. Complete with two spare cotton wicks and 50 cc distilled water container.
- TP3204** Natural ventilation wet bulb probe for long-lasting measurements. Capacity: 500 cc of distilled water. Pt100 sensor. 2 m cable with 4-pole M12 connector. Complete with 500 cc bottle and two spare cotton wicks.
- TP3575TC2** Globe-thermometer temperature probe. Pt100 sensor. Globe Ø 150 mm. Stem: Ø 14 mm, length 110 mm. 2 m cable with 4-pole M12 connector.
- TP3576TC2** Globe-thermometer temperature probe. Pt100 sensor. Globe Ø 50 mm. Stem: Ø 8 mm, length 170 mm. 2 m cable with 4-pole M12 connector.
- TP3507TC2** 1/3 DIN Pt100 temperature probe. Stem: Ø 14 mm, length 140 mm. 2 m cable with 8-pole M12 connector. The outdoor installation of the probe requires the **optional** HD9007A-3 protection against solar radiations.
- HD32.2.7.1** Holder for probes, to be fixed on the tripod.
- VTRAP30** Tripod, height 157 mm.
- HD9007A-3** 6-ring protection from solar radiations for the HP3517ETC2... probe.
- HD9007T26.2** Fitting for Ø 14 mm probes for the HD9007A-3 protection from solar radiations.
- HD32.4.17** Bracket for fixing the WBGT measurement system to a wall or a mast.
- HD2013.2.14** 3-sector clamping for mast Ø 40 mm with 6 inputs Ø 16 mm.
- HD3218K** Clamp shaft for fixing a probe to the HD2013.2.14 flange.

PHOTOMETRIC PROBE

- LP35PHOT** Photometric probe for measuring illuminance, CIE photopic filter, spectral response according to the standard photopic curve, diffuser for cosine correction. Measuring range: 0.1...200,000 lux. Cable length 5 m.
- LPBL** Base with levelling device for the photometric probe.
- LPBL3** Adjustable wall support for the photometric probe.

LEAF WETNESS SENSOR

- HP3501...** Leaf wetness sensor with double sensitive surface. IP 67 protection degree. 5 m (HP3501.5) or 10 m (HP3501.10) cable with M12 connector.

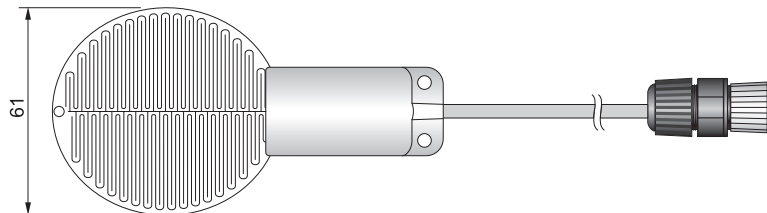

SOIL VOLUMETRIC WATER CONTENT SENSORS

HP3510.1... 2-electrode probe for measuring the soil volumetric water content. With integrated NTC temperature sensor. 5 m (HP3510.1.5) or 10 m (HP3510.1.10) cable with M12 connector.

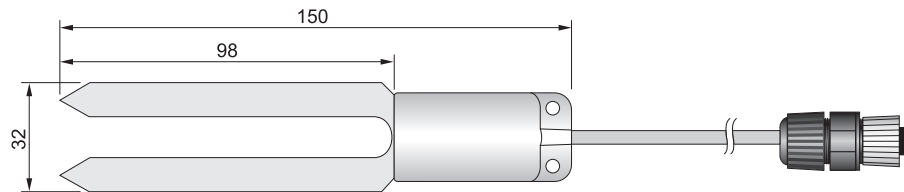

HP3510.2... 3-electrode probe for measuring the soil volumetric water content in restricted volumes. With integrated NTC temperature sensor. 5 m (HP3510.2.5) or 10 m (HP3510.2.10) cable with M12 connector.

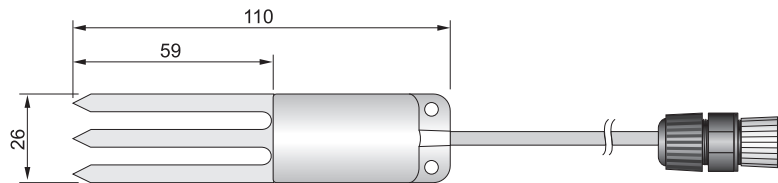

LEVEL SENSOR

HP712 Stainless steel level sensor. Measuring principle: detection of the pressure relative to the atmosphere. Measuring range 0...1 bar. Maximum overpressure 4.5 bar. Operating temperature -20...+80 °C. Protection degree IP 68. Cable ended with open wires.

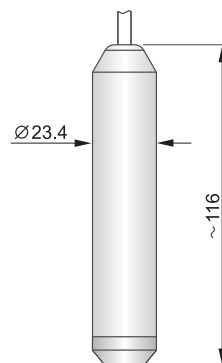

OTHER SENSORS

For rain gauges, anemometers, pyranometers and other radiometric sensors, please visit www.deltaohm.com or contact Delta OHM directly.

ACCESSORIES

SWD06 100-240 Vac / 6 Vdc - 1 A mains power supply.

CP31 Direct USB connection cable with mini-USB male connector on the instrument side and A-type USB male connector on the PC side.

CPM12-8D... Cable with 8-pole M12 connector on one side, free wires on the other. Length 5 m (CPM12-8D.5) or 10 m (CPM12-8D.10). For RS485 connection of HD35APS base unit.

CPM12AA4... Cable with 4-pole M12 connector on one side, free wires on the other. Length 5 m (CPM12AA4.5) or 10 m (CPM12AA4.10).

HD35.03 Spare plastic support for removable installation of indoor models.

HD35.11K	Pair of flanges in anodized aluminum alloy for fixed installation of indoor models. Lock pin and padlock included.
HD35.24W	Flange in anodized aluminum alloy for fixing to the wall the outdoor models. Not suitable for HD35EDW1NB...TV.
HD35.24C	Kit including the HD35.24W flange and a clamp for fixing the flange to a Ø 40...50 mm mast.
HD35.37	Pair of flanges in anodized aluminum alloy for fixing to the wall the models HD35EDW1NB...TV.
HD35-BAT1	3.6 V Lithium-ion rechargeable battery, capacity 2250 mA/h, JST 3-pole connector. For HD35APS, HD35APW, HD35APxG and HD35RE.
HD35-BAT2 (*)	3.6 V size A Li-SOCl ₂ non rechargeable battery, Molex 5264 2-pole connector. For all HD35ED... models powered by Li-SOCl ₂ battery except HD35EDWK/4TC, HD35EDW[D]PTC, HD35EDW1NLTC, HD35WS...TC and HD35EDWH.
BAT-2013DB (*)	3.6 V size C Li-SOCl ₂ non rechargeable battery, Molex 5264 2-pole connector. For HD35EDWK/4TC, HD35EDW[D]PTC, HD35EDW1NLTC, HD35WS...TC and HD35EDWH.
HD75	Saturated solution to check Relative Humidity probes at 75% RH, includes ring adapter for Ø14 mm probes, thread M12×1.
HD33	Saturated solution to check Relative Humidity probes at 33% RH, includes ring adapter for Ø14 mm probes, thread M12×1.
HD11	Saturated solution to check Relative Humidity probes at 11% RH, includes ring adapter for Ø14 mm probes, thread M12×1.
HD31.B3A	Adapter for the calibration of the CO ₂ sensor with the nitrogen can. Only for the models HD35EDW1NB...TV.

(*) The models HD35EDW1[4b]7PTC, HD35EDWRTC, HD35EDWPTC and HD35EDWWBGT in the "J" version (915.9-929.7 MHz) use BAT-2013DB instead of HD35-BAT2.

DELTA OHM metrology laboratories LAT N° 124 are accredited ISO/IEC 17025 by ACCREDIA for Temperature, Humidity, Pressure, Photometry / Radiometry, Acoustics and Air Velocity. They can supply calibration certificates for the accredited quantities.

Approvals

Sub-GHz certifications:

Models HD35...**U** contain transmitter module FCC ID: X7J-A10040601
IC ID: 8975A-A10040601

Model HD35...**J** contains TELEC certified RF module: [R] 006-000411



IEEE 802.11 (Wi-Fi) certifications:

Models HD35APW... contain IEEE 802.11b/g/n certified RF module:

S/N < 23006384: FCC ID: XM5-SMG2N2
IC ID: 8516A-SMG2N2
TELEC: [R] 204-520077



S/N ≥ 23006384: FCC ID: QOQWGM160P
IC ID: 5123A-WGM160P
KC: R-C-BGT-WGM160P
TELEC: [R] 005-102265

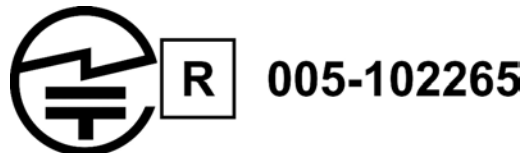

GSM certifications:

Models HD35APG.**E** and HD35APG.**U** contain GSM/GPRS module FCC ID: XMR201202M95
IC ID: 10224A-201202M95

3G certifications:

Models HD35AP3G... contain 3G/GSM module FCC ID: QIPEHS6
IC ID: 7830A-EHS6
ANATEL: 3954-13-5015
TELEC certified RF module: [R] 003-150064

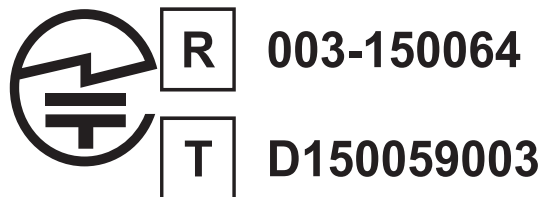

4G certifications:

Models HD35AP4G... contain LTE module FCC ID: XMR201903EG25G
IC ID: 10224A-201903EG25G
ANATEL: 02828-19-07968
TELEC certified RF module: [R] 201-190133



FCC and IC notices

Notice: This device complies with Part 15 -15.247(a2) and 15.247(b) and 15.249 of the FCC Rules and with Industry Canada (IC) licence-exempt RSS standard(s). Operation is subject to the following two conditions: (1) this device may not cause harmful interference, and (2) this device must accept any interference received, including interference that may cause undesired operation.

Avis: *Cet appareil est conforme avec Part 15 -15.247(a2) et 15.247(b) et 15.249 des règlements FCC et Industrie Canada (IC) RSS standard exempts de licence(s). Son fonctionnement est soumis aux deux conditions suivantes: (1) cet appareil ne peut pas provoquer d'interférence et (2) cet appareil doit accepter toute interférence, y compris les interférences qui peuvent causer un mauvais fonctionnement du dispositif.*

Notice: This equipment has been tested and found to comply with the limits for Class B digital device, pursuant to part 15 of the FCC Rules. These limits are designed to provide reasonable protection against harmful interference in a residential installation. This equipment generates, uses and radiates radio frequency energy, and, if not installed and used in accordance with the instructions, may cause harmful interference to radio communications. However, there is no guarantee that interference will not occur in a particular installation. If this equipment does cause harmful interference to radio or television reception, which can be determined by turning the equipment off and on, the user is encouraged to try to correct the interference by one or more of the following measure:

- Reorient or relocate the receiving antenna.
- Increase the separation between the equipment and receiver.
- Connect the equipment into an outlet on a circuit different from that to which the receiver is connected.
- Consult the dealer or an experienced radio/TV technician for help.

Notice: To satisfy FCC/IC RF exposure requirements for mobile and base station transmission devices, a separation distance of 20 cm or more should be maintained between the antenna of this device and persons during operation. To ensure compliance, operation at closer than this distance is not recommended. The antenna(s) used for this transmitter must not be co-located or operating in conjunction with any other antenna or transmitter.

Avis: *Pour répondre aux exigences d'exposition RF FCC/IC pour les dispositifs de transmission mobiles et les stations de base, une distance de séparation de 20 cm ou plus doit être maintenue entre l'antenne de l'appareil et des personnes en cours de fonctionnement. Pour assurer la conformité, l'exploitation de plus près à cette distance n'est pas recommandée. L'antenne(s) utilisé pour cet émetteur ne doit pas être co-localisés ou fonctionner conjointement avec une autre antenne ou transmetteur.*

Notice: Under Industry Canada regulations, this radio transmitter may only operate using an antenna of a type and maximum (or lesser) gain approved for the transmitter by Industry Canada. To reduce potential radio interference to other users, the antenna type and its gain should be so chosen that the equivalent isotropically radiated power (e.i.r.p.) is not more than that necessary for successful communication.

Avis: *Conformément à la réglementation d'Industrie Canada, le présent émetteur radio peut fonctionner avec une antenne d'un type et d'un gain maximal (ou inférieur) approuvé pour l'émetteur par Industrie Canada. Dans le but de réduire les risques de brouillage radioélectrique à l'intention des autres utilisateurs, il faut choisir le type d'antenne et son gain de sorte que la puissance isotrope rayonnée équivalente (p.i.r.e.) ne dépasse pas l'intensité nécessaire à l'établissement d'une communication satisfaisante.*

Notes

Notes

WARRANTY

The manufacturer is required to respond to the "factory warranty" only in those cases provided by Legislative Decree 6 September 2005 - n. 206. Each instrument is sold after rigorous inspections; if any manufacturing defect is found, it is necessary to contact the distributor where the instrument was purchased from. During the warranty period (24 months from the date of invoice) any manufacturing defects found will be repaired free of charge. Misuse, wear, neglect, lack or inefficient maintenance as well as theft and damage during transport are excluded. Warranty does not apply if changes, tampering or unauthorized repairs are made on the product. Solutions, probes, electrodes and microphones are not guaranteed as the improper use, even for a few minutes, may cause irreparable damages.

The manufacturer repairs the products that show defects of construction in accordance with the terms and conditions of warranty included in the manual of the product. For any dispute, the competent court is the Court of Padua. The Italian law and the "Convention on Contracts for the International Sales of Goods" apply.

TECHNICAL INFORMATION

The quality level of our instruments is the result of the continuous product development. This may lead to differences between the information reported in the manual and the instrument you have purchased.

We reserves the right to change technical specifications and dimensions to fit the product requirements without prior notice.

DISPOSAL INFORMATION

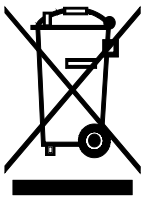

Electrical and electronic equipment marked with specific symbol in compliance with 2012/19/EU Directive must be disposed of separately from household waste. European users can hand them over to the dealer or to the manufacturer when purchasing a new electrical and electronic equipment, or to a WEEE collection point designated by local authorities. Illegal disposal is punished by law.

Disposing of electrical and electronic equipment separately from normal waste helps to preserve natural resources and allows materials to be recycled in an environmentally friendly way without risks to human health.

CE RoHS



senseca

Please note our new name:
Senseca Italy Srl
Via Marconi 5, 35030 Padua, Italy
Documents are in the process of being changed.