

## Operating manual

Low pressure  
transmitter / data logger

### HD50CR



Members of GHM GROUP:

**GREISINGER**

**HONSBERG**

**Martens**

**Delta OHM**

**VAL.CO**

[www.deltaohm.com](http://www.deltaohm.com)

Keep for future reference.

# TABLE OF CONTENTS

<b>1</b>	<b>INTRODUCTION</b> .....	<b>3</b>
<b>2</b>	<b>DESCRIPTION</b> .....	<b>4</b>
<b>3</b>	<b>INSTALLATION</b> .....	<b>5</b>
	3.1 CONFIGURATION .....	6
<b>4</b>	<b>CONNECTION TO THE LOCAL NETWORK</b> .....	<b>8</b>
	4.1 HD35AP-CFR21 SOFTWARE OPTION .....	8
<b>5</b>	<b>ALARMS</b> .....	<b>10</b>
<b>6</b>	<b>STATISTICAL FUNCTIONS</b> .....	<b>12</b>
<b>7</b>	<b>CALIBRATION</b> .....	<b>13</b>
<b>8</b>	<b>WEB SERVER</b> .....	<b>14</b>
	8.1 SETTINGS MENU .....	15
	8.2 MONITOR MENU .....	20
	8.3 CONNECTIVITY MENU .....	22
	8.4 FILES MENU.....	29
<b>9</b>	<b>MENU</b> .....	<b>30</b>
<b>10</b>	<b>MODBUS</b> .....	<b>36</b>
<b>11</b>	<b>TECHNICAL CHARACTERISTICS</b> .....	<b>42</b>
<b>12</b>	<b>INSTRUMENT STORAGE</b> .....	<b>45</b>
<b>13</b>	<b>SAFETY INSTRUCTIONS</b> .....	<b>45</b>
<b>14</b>	<b>PROBES AND ACCESSORIES ORDERING CODES</b> .....	<b>46</b>

# 1 INTRODUCTION

**HD50CR** is a relative or differential low pressure transmitter and data logger designed for wall flush-mounting. Measuring range  $\pm 125$  Pa.

A silicon piezoresistive sensor with high accuracy and temperature compensation is used, which allows excellent linearity, repeatability and stability over the time. The auto-zeroing feature allows stable measurements over the time without the need to recalibrate.

An input for an optional relative humidity and temperature combined probe is provided. The absolute humidity, the Dew Point and the wet bulb temperature are calculated.

Three 0...5/10 V and 0/4...20 mA analog outputs and a digital RS485 output with "**Slave**" **Modbus-RTU** protocol for connecting the instrument to a network of sensors are available.

The electroluminescent display has an inattinic red protection. The front keyboard allows scrolling the real time measurements and configuring the instrument.

The instrument can be connected to a local network via the **Ethernet** interface (optionally Wi-Fi, on request). The simultaneous operation of two communication protocols (proprietary and **Modbus TCP/IP**) is possible. The instrument manages up to 10 "TCP/IP Client" simultaneously. If the local network is connected to Internet, the data can be regularly sent to an **FTP** address, to the **Cloud** and via **e-mail**.

Equipped with a USB port with mini-USB connector for the direct connection to a PC.

For each detected quantity, two alarm thresholds can be set by the user. Exceeding a threshold is signaled acoustically, by means of the internal buzzer, visually, by lighting the alarm LEDs on the front panel (only for the three measurements associated with the analog outputs), and remotely, by sending alarm **e-mails**. An alarm hysteresis and a delay in the generation of the alarm can be configured for each detected quantity.

Thanks to the integrated web server, you can configure the instrument and view the real time measurements from any PC, tablet or smartphone connected to the same local network of the instrument by simply using a web browser.

The PC software **HD35AP-S** allows configuring the instrument, viewing the real time measurements, downloading and viewing the data into a database. The HD35AP-S software allows connecting one instrument at a time. If there are several HD50CR instruments in the local network, the PC software **HDServer1** allows detecting automatically all the instruments connected to the network and the simultaneous connection to all the instruments, entering the data received by the instruments into a database, viewing the data in the database and configuring some basic parameters of the devices (alarms, logging interval, ...). The **HD35AP-CFR21** software option (available with both HD35AP-S and HDServer1) allows the protection of recorded data and configuration in response to **FDA 21 CFR part 11** recommendations.

The internal clock can be regularly synchronized with a NIST reference server.

Brushed stainless steel front panel.

The instrument is supplied factory calibrated.

## 2 DESCRIPTION

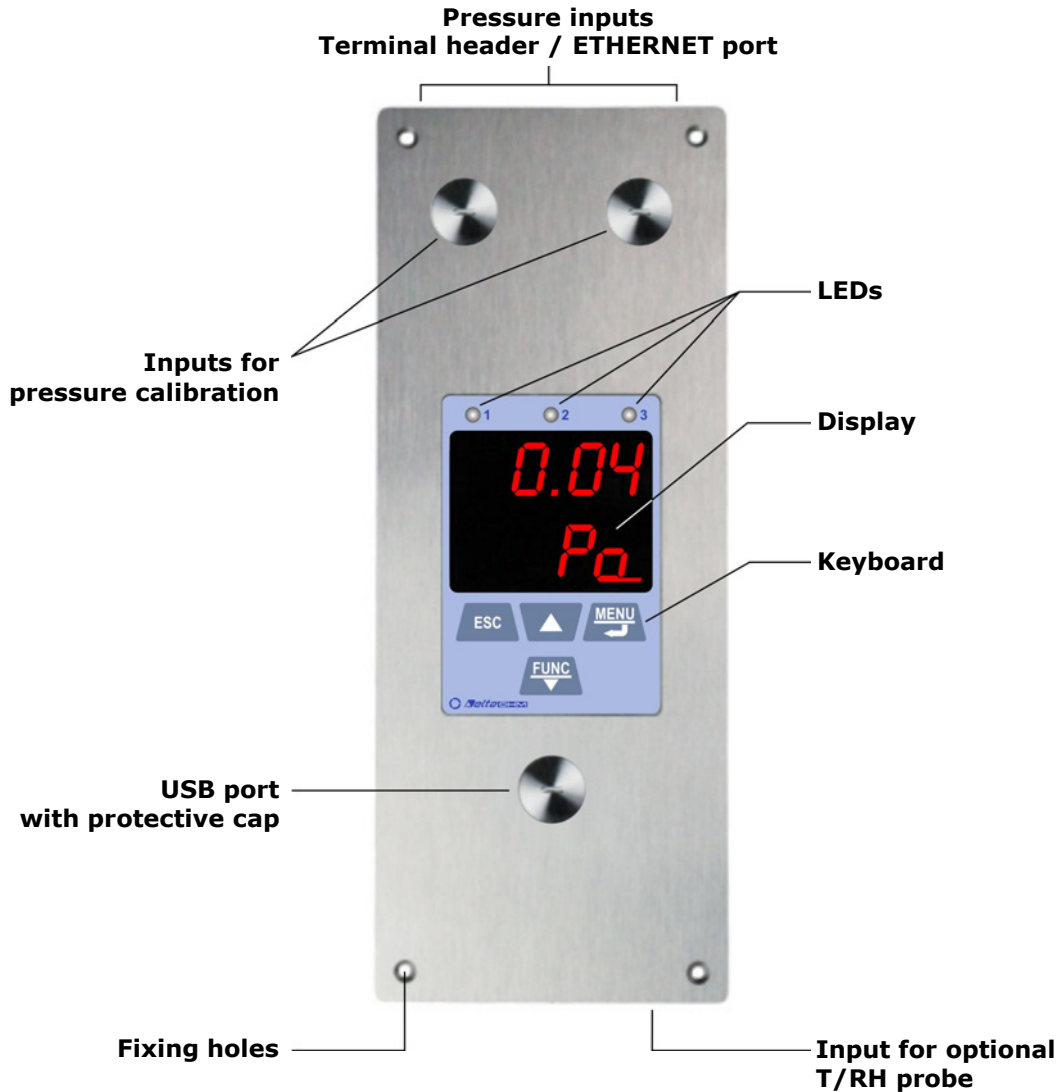

### Buttons:



Scrolls the real time measurement on the display.  
In menu, increases the displayed value or move to the next parameter.



Displays the statistical functions (MIN, MAX, AVG).  
In menu, decreases the displayed value or move to the previous parameter.



Enters the menu.  
In menu, confirms the displayed value.



Cancel the operation or goes back to the previous level.

### 3 INSTALLATION

Make a 196 x 70 mm cut in the wall, at least 46 mm deep, and 4 holes according to the drilling pattern shown below, then wall mount the instrument by using the 4 holes on the front panel.

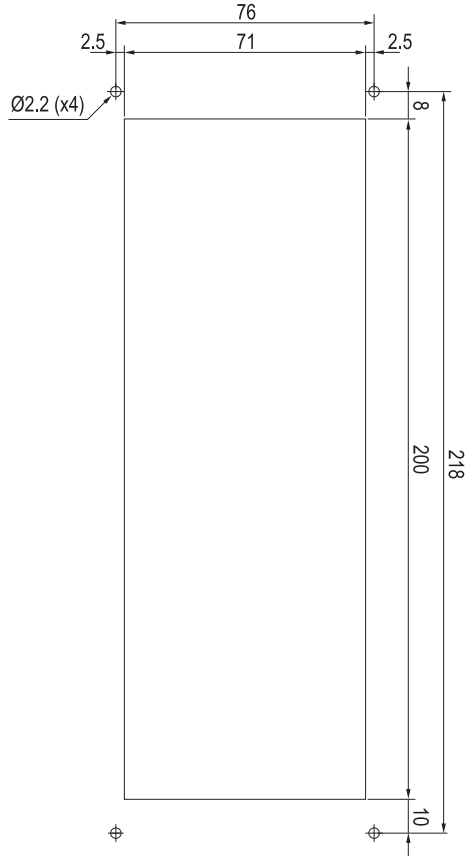

The connections on the upper part of the housing are as follows:

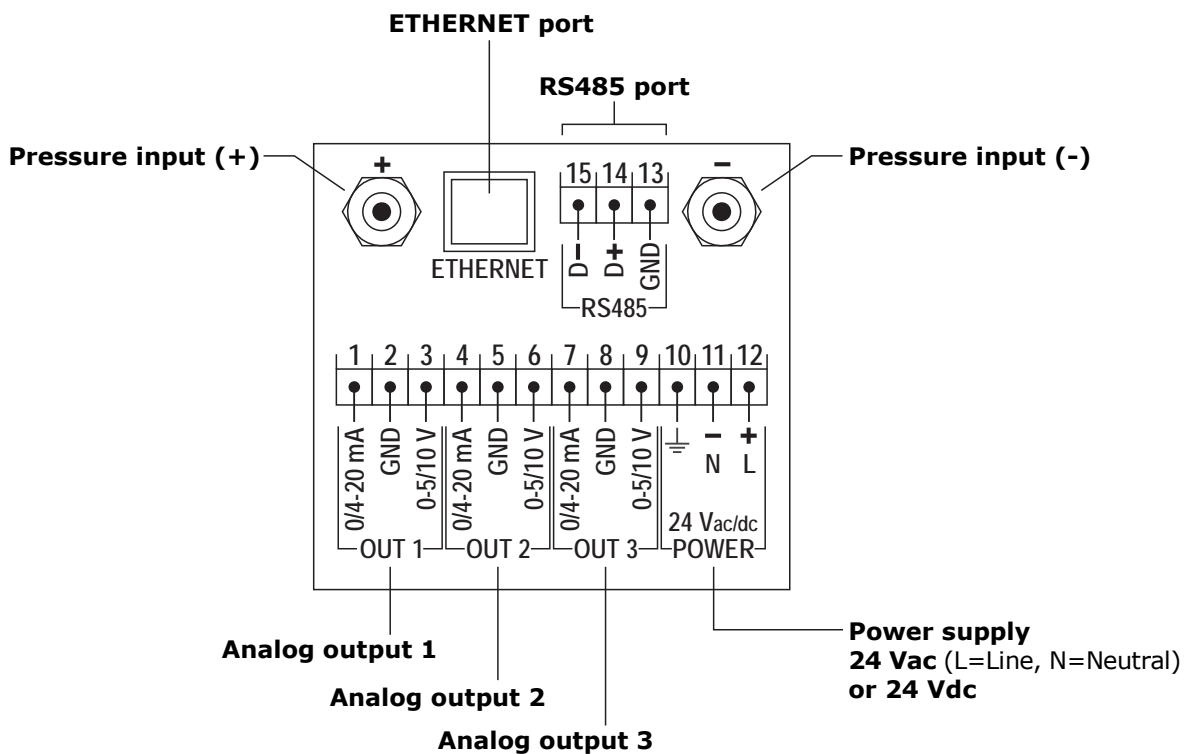

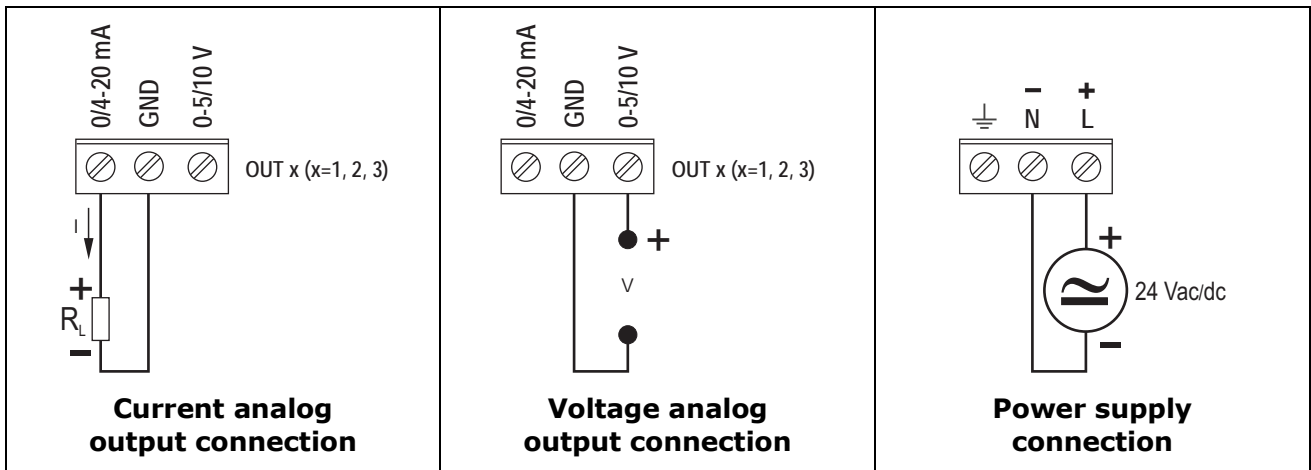

The three analog outputs are associated with the first three quantities of the list of selected quantities in the *CHANNELS* panel of the "web server" (see chapter 8) or, equivalently, with the quantities of index CH1, CH2 and CH3 set in the F200 menu via the front keyboard of the instrument (see chapter 9).

The current analog output and the voltage analog output of the same channel (1, 2 or 3) are associated with the same quantity.

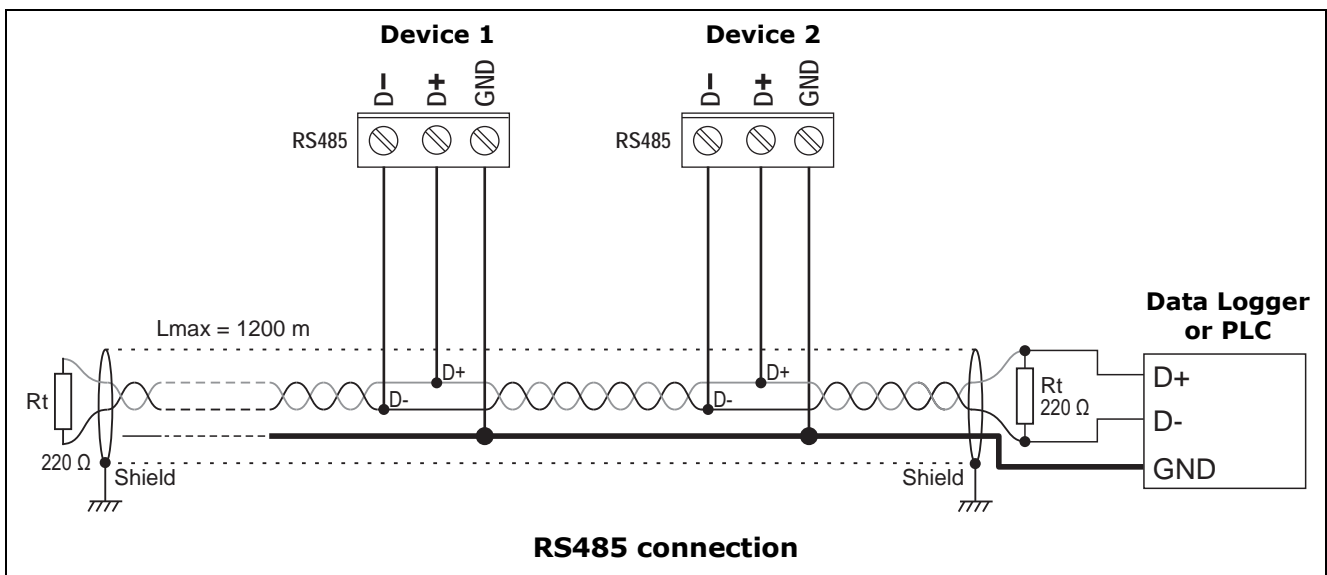

Connect any combined temperature and relative humidity probe to the 8-pole M12 connector on the bottom of the housing.

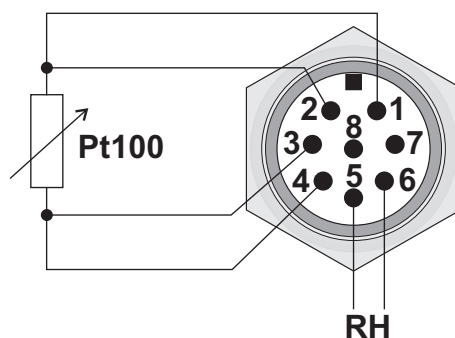

**Pinout of the external side of the male M12 connector of the transmitter**

### **3.1 CONFIGURATION**

---

The operating parameters of the instrument can be configured in various way:

- Via front keyboard (see chapter 9).
- Via the web server feature of the instrument (see chapter 8).
- Via the HD35AP-S application software, connecting the instrument to the PC via USB or local network.
- Via the HDServer1 application software (only for some basic parameters: alarms, logging interval, user code, ...), connecting the instrument to the PC via local network.
- Via the Modbus protocol and the RS485 connection, for the Modbus-RTU protocol, or Ethernet connection, for the Modbus TCP/IP protocol (see chapter 10).

The HD35AP-S and HDServer1 application softwares are downloadable from Delta OHM website. For the use of the application softwares, see the corresponding instructions.

## 4 CONNECTION TO THE LOCAL NETWORK

The instrument can be connected to the local network via **Ethernet** interface (optionally Wi-Fi, on request; the two interfaces are alternatives, they cannot be used simultaneously).

To connect the instrument to an Ethernet network, connect the RJ45 connector of the instrument to a socket of the local network via a standard Ethernet cable.

The instrument is preset to get a dynamic IP address from the network DHCP server. A static IP address can be set by using the web server feature of the instrument or the HD35AP-S application software. The IP address is displayed at the end of the list of quantities that can be scrolled by using the "up arrow" key.

To connect the instrument to a Wi-Fi network (optional), you must first change the setting of the instrument interface by connecting the instrument to the PC via Ethernet and using the web server feature of the instrument (see the panel *CONNECTIVITY >> NETWORK* in paragraph 8.3) or the HD35AP-S software. Alternatively, connect the instrument to the PC via USB through the front mini-USB connector (unscrew the protective cap) and use the HD35AP-S software.

The instrument can be accessed from any PC of the local network. To download the data in a database, the **HD35AP-S** (it allows connecting one instrument at a time) or **HDServer1** (it allows connecting several instruments simultaneously) application software and the **MySQL** database management system (included in the HD35AP-S software package) must be installed.

Thanks to the availability of two TCP/IP listening ports, each of which can operate with proprietary (for the connection with HD35AP-S software) or **MODBUS TCP/IP** protocol, and ten sockets (in total, to be divided between the two ports), the instrument allows the simultaneous operation of two communication protocols (proprietary and Modbus TCP/IP) and manages up to **10 "TCP/IP Client"** simultaneously. The default setting of the ports is the following:

- Port number = 5100 for proprietary protocol (8 sockets)
- Port number = 502 for Modbus TCP/IP protocol (2 sockets)

If the local network is connected to Internet, the data can be regularly sent to an **FTP** address, to the **Cloud** and via **e-mail** (as attachments).

*Note:* if the communication with the Cloud or the HDServer1 software is used, the maximum number of "clients" with proprietary or **MODBUS TCP/IP** protocol is nine.

To configure the TCP/IP ports and the sending of data over the Internet, use the web server feature of the instrument or the HD35AP-S software.

### 4.1 HD35AP-CFR21 SOFTWARE OPTION

---

The **HD35AP-CFR21** option allows, in addition to the features of the basic software (both HD35AP-S and HDServer1), the protection of recorded data and instrument configuration in response to **FDA 21 CFR part 11** recommendations. In particular, become available:

- The traceability of activities (Audit Trail) performed with the software; for example, which users connected and what changes were possibly made to the configuration of the instrument.
- The management of users access for the instrument configuration and viewing of



data in the database. Each user can be assigned a different password for using the software. There are also three levels of access (Administrator, Super-user and standard User); for each level, the allowed operations can be defined.

The HD35AP-CFR21 option works with USB hardware key to be connected to any PC connected to the same local network of the PC in which the basic software is installed.

*Note: if the HD35AP-CFR21 option is used, the instrument integrated web server allows viewing measurements and configuration, but not the modification of the instrument configuration, because the settings changed via web server cannot be traced.*

## 5 ALARMS

For each detected quantity, two alarm thresholds can be set by the user. The alarm is generated if the measured value falls below the lower threshold or rises above the upper threshold.

Exceeding a threshold is signaled:

- acoustically, by means of the internal buzzer (if enabled);
- visually, by lighting the alarm LEDs on the front panel (only for the three measurements associated with the analog outputs);
- remotely, by sending alarm **e-mails** (if enabled).

An alarm hysteresis and a delay in the generation of the alarm can be configured for each detected quantity.

The amplitude of the hysteresis is in percentage (0...100%) of the difference between the two alarm thresholds. For example, if the hysteresis is 2% (default value), the lower threshold is 10 °C and the upper threshold is 60 °C, the hysteresis in °C is equal to  $(60-10) \times 2/100 = 1 \text{ °C}$ .

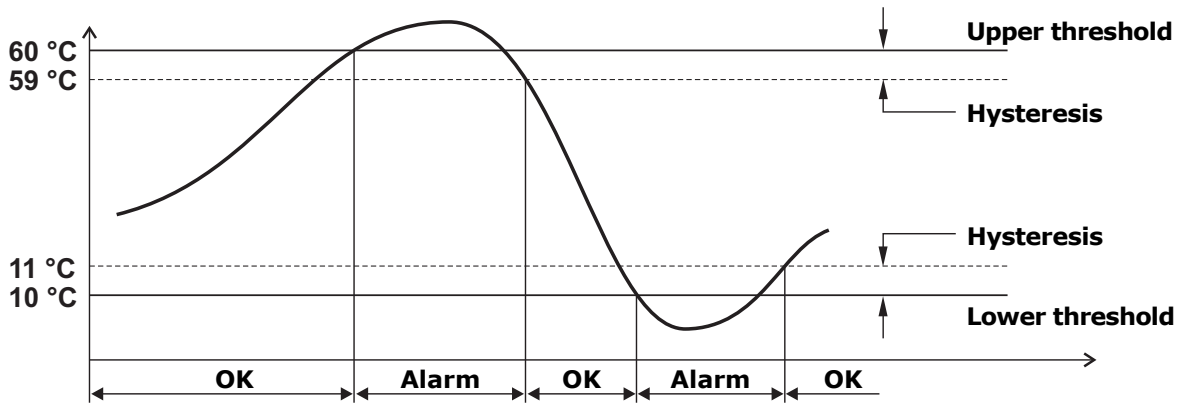

The alarm is generated after the set delay time or immediately if the “no delay” option is selected (default). If the alarm condition disappears before the delay time has elapsed, the alarm is not generated.

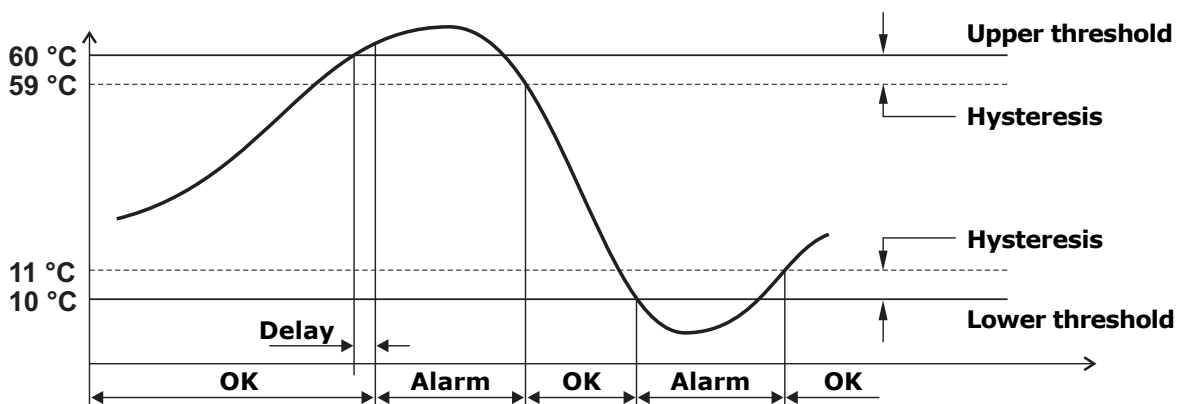

Enabling the Buzzer *Latch* option, the buzzer continues to sound even after the alarm condition has ceased.

In the event of an alarm in progress with the buzzer active, the buzzer can be silenced

for a configurable time. Once the set time has elapsed, the buzzer will resume sounding or not depending on whether the alarm condition is still present or not.

The following example shows the silencing of the buzzer with *Latch* option disabled.

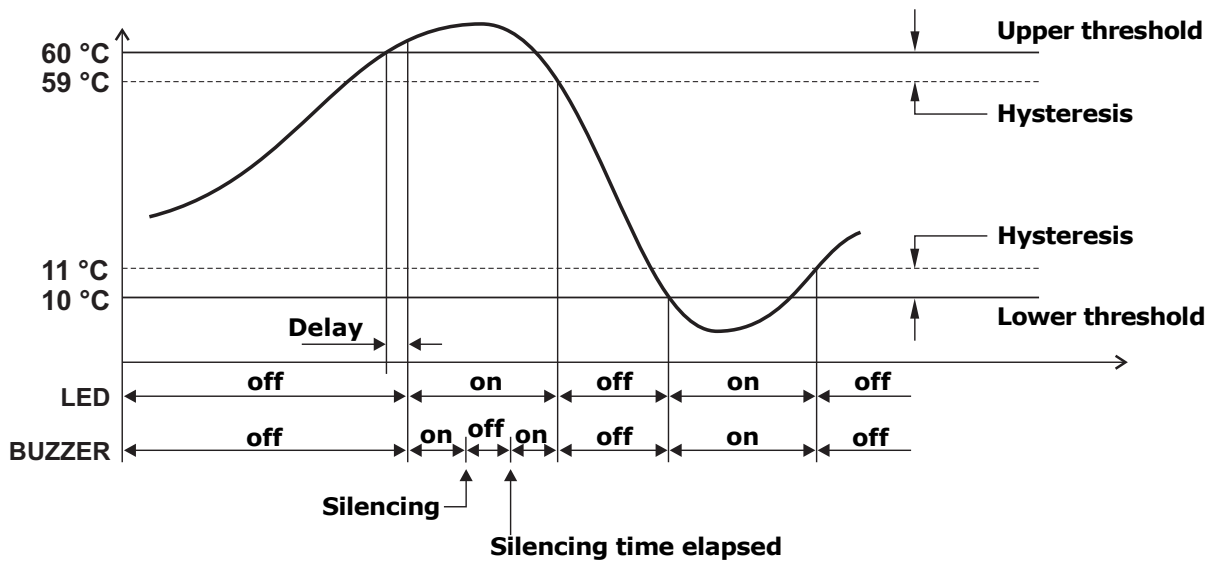

The following example shows the silencing of the buzzer with *Latch* option enabled.

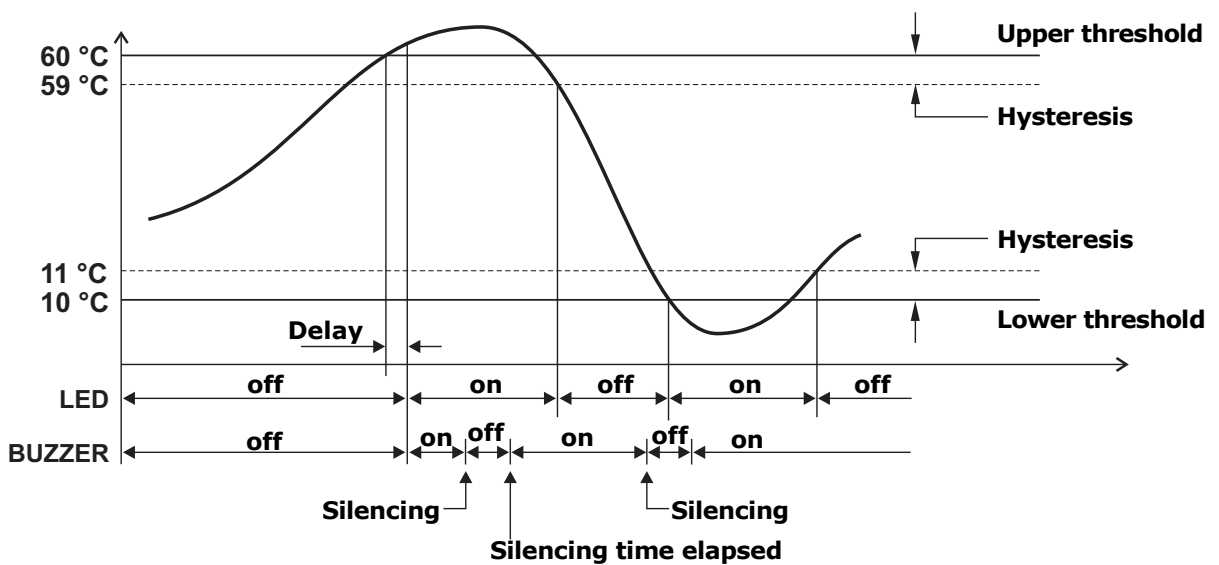

## 6 STATISTICAL FUNCTIONS

The instrument calculates and displays the maximum (MAX), minimum (MIN) and average (AVG) value of the detected measurements.

In order to display the statistical information, press **FUNC/▼**: the instrument shows the maximum value of the displayed quantity. To scroll the maximum values of the various quantities use the **▲** key.

By pressing **FUNC/▼** again, the instrument shows the minimum value of the displayed quantity. By pressing **FUNC/▼** again, the instrument shows the average value of the displayed quantity.

By pressing **FUNC/▼** once more, the instrument asks if the calculation of the statistical values is to be reset (FUNC CLR). Select *YES* or *nO* using **▼/▲** keys, then confirm with the **MENU/↵** key.

## 7 CALIBRATION

The instrument calibrates automatically at regular intervals (default 60 minutes, the interval is configurable) the zero of the differential pressure, temporarily disconnecting the pressure inputs through an internal solenoid valve.

Via the Fc00 menu (see chapter 9) it is possible to perform a manual calibration in one or two points. In order to perform manual calibration, it is necessary to unscrew the two front caps that cover the calibration inputs. To perform zero calibration (Fc05 in the menu), leave both inputs open. To perform calibration at non-zero values (gain calibration, Fc08 in the menu), connect the front inputs to a low differential pressure generator.

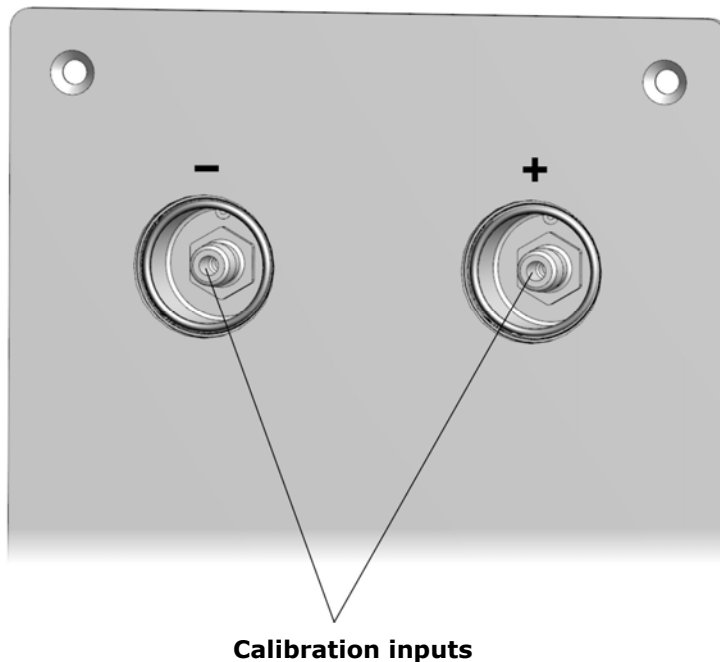

The differential pressure zero calibration is also possible via the Modbus Coil register with address 72 (see chapter 10).

At the end of the calibration or verification, firmly screw the front caps so that the seal is tight and the inputs are not affected by the external pressure.

Via the Fc00 menu it is also possible to calibrate the relative humidity sensor of the combined temperature and relative humidity probe at points 33% RH and 75% RH.

**Warning:** the optional combined relative humidity and temperature probe must be calibrated in line with the instrument. If the probe is ordered with the instrument, the probe is already factory calibrated. If the probe is ordered later, the calibration must be performed by the user via the Fc00 menu.

## 8 WEB SERVER

The instrument has an integrated web server through which you can configure the instrument and view the real time measurements from any PC, tablet or smartphone connected to the same local network of the instrument by simply using a web browser.

To connect to the web server, type the IP address of the instrument in the address bar of the web browser of your device (PC, tablet, smartphone, ...).

*Note:* the IP address is displayed at the end of the list of quantities that can be scrolled by using the “up arrow” key.

*Note:* if a port number other than the standard HTTP (80) has been set in the instrument, the port number must be specified after the IP address (*IPaddress:port number*).

In the web server starting window, enter the user name and the password supplied with the instrument, then press *Submit*.

### Structure of the web server menu:

<b>SETTINGS</b>	
INFO	Instrument general information
CONFIGURATION	Modbus parameters, user code and belonging group
MEASURES	Selection of the quantities to be displayed
LOGGING	Logging settings
ALARMS	Setting of the alarms
UNITS	Units of measurement
CHANNELS	Selection of the quantities to be displayed with the Monitor function
OUTPUTS	Setting of the analog outputs
<b>MONITOR</b>	
MEASURES	Display of the real time measurements
CHART	Graphs of the measurements acquired by the Monitor function
SETUP	Settings of the graphs of the measurements
TABLE	Numeric table of the measurements acquired by the Monitor function
<b>CONNECTIVITY</b>	
NETWORK	LAN/WLAN settings (Wi-Fi or Ethernet choice, IP address, etc.)
WIFI	List of the available Wi-Fi networks (Wi-Fi connection is optional)
EMAIL	Settings for sending e-mails
FTP	Settings for sending data via FTP
CLOUD	Settings for sending data to the Cloud
SERVER	Settings for the connection with the HDServer1 software
CLOCK	Setting of the automatic clock synchronization
<b>FILES</b>	
LOAD	Import of data files
CHART	Graphs of imported measurements
SETUP	Settings of the graphs of imported measurements
TABLE	Numeric table of imported measurements

## 8.1 SETTINGS MENU

The SETTINGS menu allows viewing the instrument general information and configuring the Modbus parameters, the user code, the belonging group, the logging parameters, the alarms and the units of measurement. It also allows choosing the measurements to be stored in the internal memory and displayed in real time (Monitor) and in what order.

### • INFO panel

Displays the general information of the instrument:

- model, serial number
- user code
- belonging group
- Wi-Fi signal level (only if the optional Wi-Fi interface is active)
- behaviour when the internal memory is full (cyclic overwriting or not)
- logging status
- buzzer activation status
- Modbus address, firmware version
- logging interval
- measurement interval
- calibration date

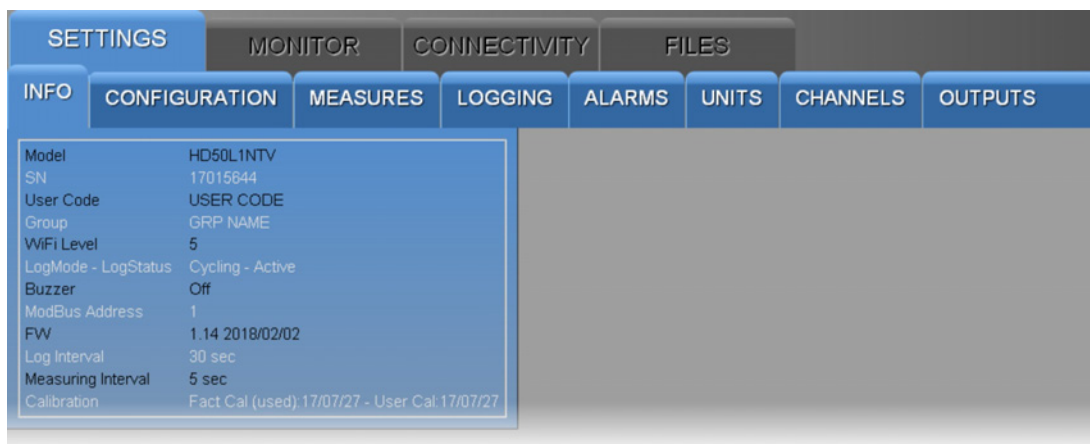

### • CONFIGURATION panel

Setting of Modbus parameters, user code and belonging group (defining a group is useful for identifying subsets of devices, for example the devices installed in the same environment).

In the Modbus section of the panel, the following parameters can be set:

- Modbus address {1...247, default = 1}
- Baud rate {96006 / 19200 / 38400 / 57600 / 115200, default = 19200 bps}
- Parity and stop bits {8N1 / 8N2 / 8E1 / 8E2 / 8O1 / 8O2, default = 8E1}
- Waiting time after transmission {Immediate Reception = violate protocol and go in receiving mode right after transmission / Wait 3.5 char = respect protocol and wait 3.5 characters after transmission, default = Immediate Reception}
- Enabling of the password for changing the configuration via Modbus {Enable/Disable, default = Disable}

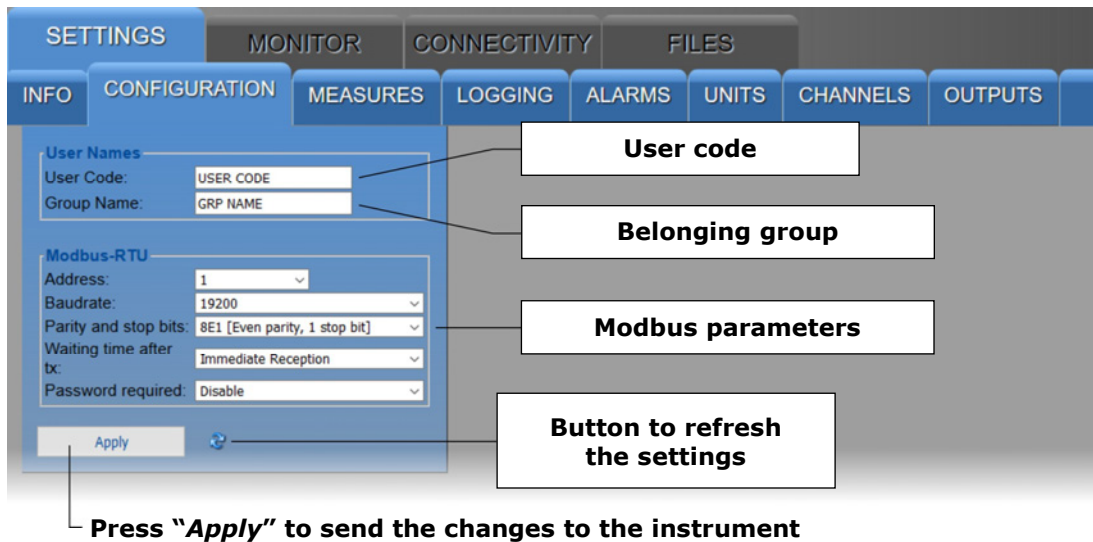

### • MEASURES panel

Selection of the quantities to be displayed cyclically on the instrument display. For each quantity, a custom name can be defined. In the panel, the resolution and the unit of measurement of each quantity are also indicated.

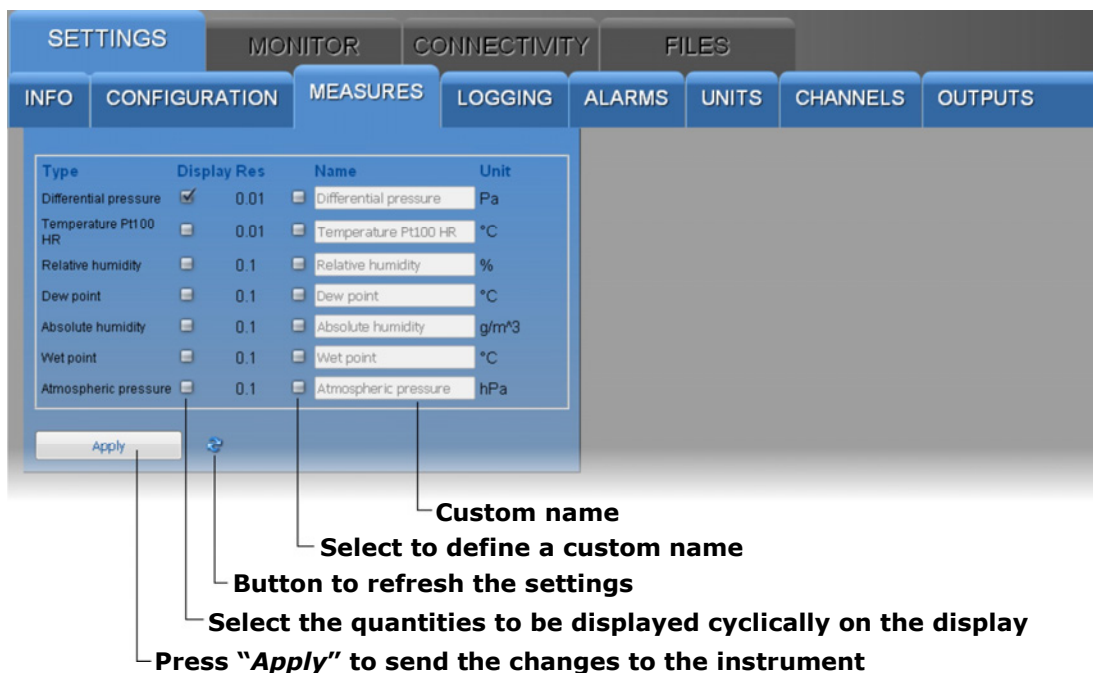

### • LOGGING panel

Setting of:

- Logging interval.
- Measuring interval.
- Logging status (active or not active).
- Memory management mode when it is full (cyclic overwriting or stop logging).



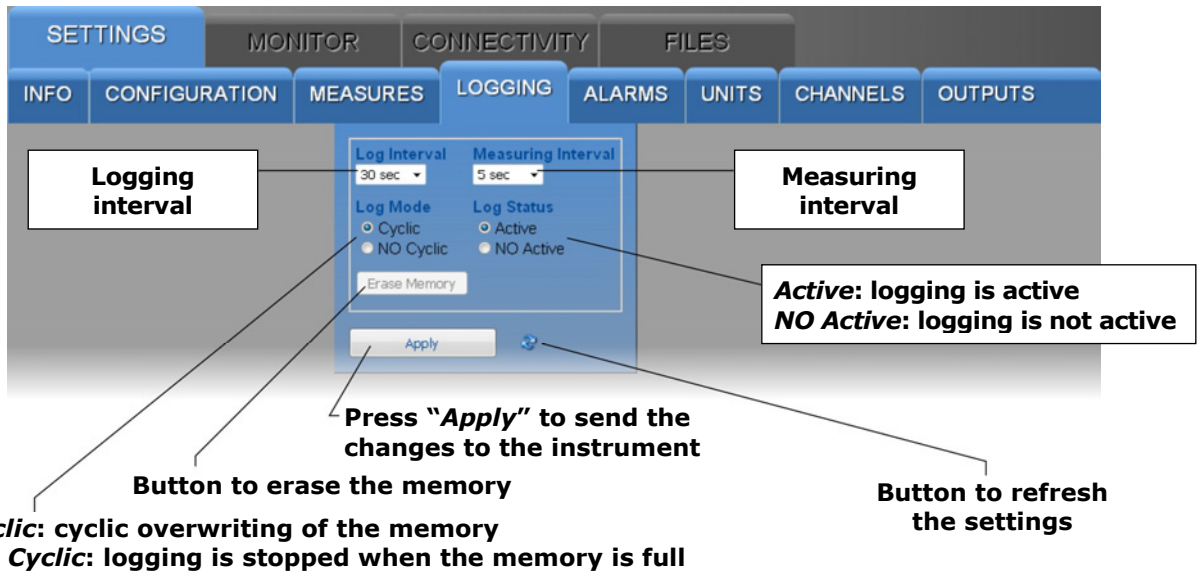

If the logging interval is greater than the measuring interval, the average of the measurements acquired during the logging interval will be stored.

The "Erase Memory" button allows erasing the data in the instrument memory.

### • ALARMS panel

Setting of the alarm thresholds and buzzer operating mode for each of the available quantities. The hysteresis, in percentage of the difference between the two alarm thresholds, and the delay time (set "no delay" for immediate activation in the event of an alarm) of the alarm can be configured.

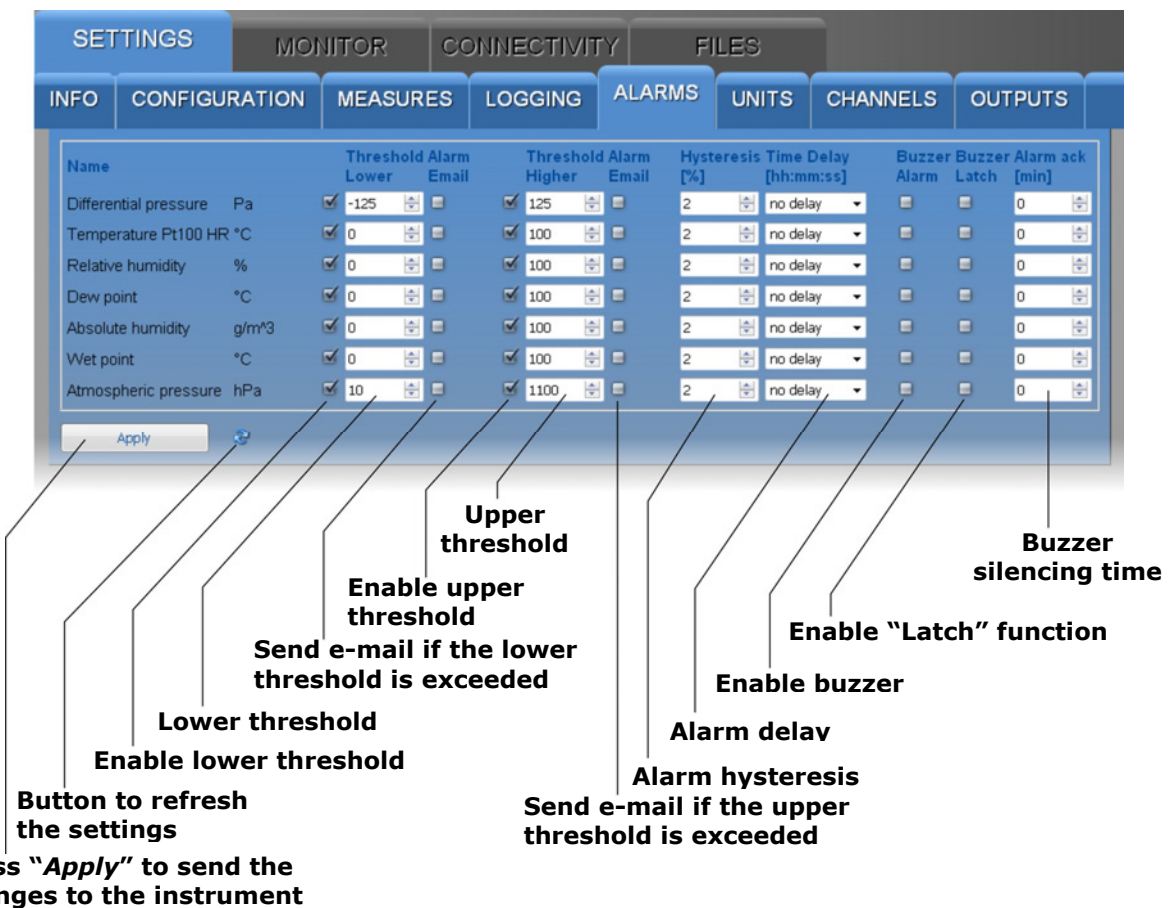

If the *Buzzer Latch* option is enabled, the buzzer continues to sound even after the alarm condition has ceased. The *Alarm ack* field allows silencing the buzzer for the set number of minutes.

• **UNITS panel**

Setting of the temperature (°C or °F) and differential pressure (mbar, bar, Pa, hPa, kPa, atm, mmHg, mmH<sub>2</sub>O, inHg, inH<sub>2</sub>O, kgf/cm<sup>2</sup> or PSI) units of measurement.

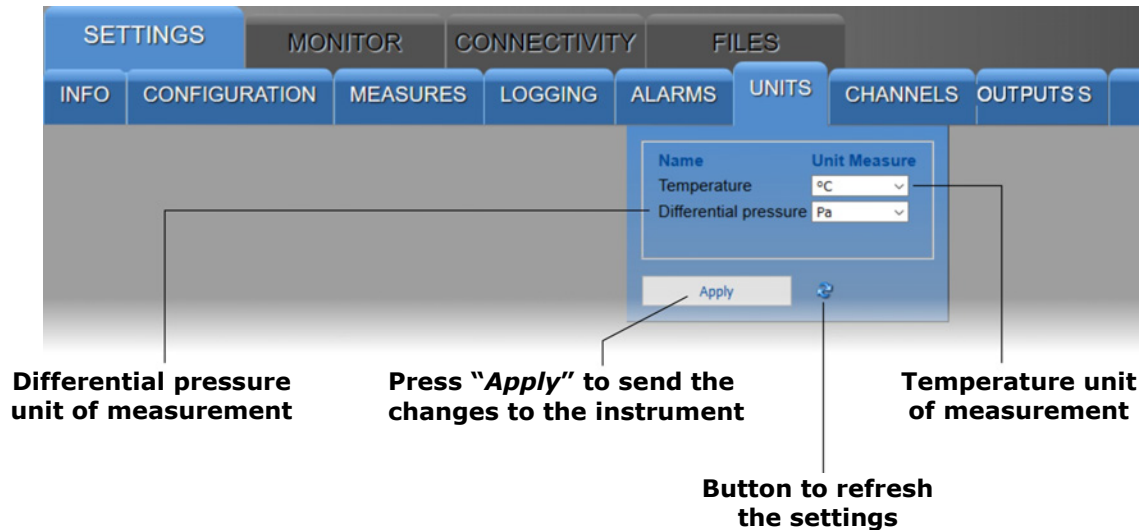

• **CHANNELS panel**

Allows choosing the measurements to be stored in the internal memory and displayed in real time with the Monitor function and in what order. The panel has two lists: the quantities available (to the left) and the quantities to be displayed (to the right). The quantities are displayed in the order in which they appear in the list on the right.

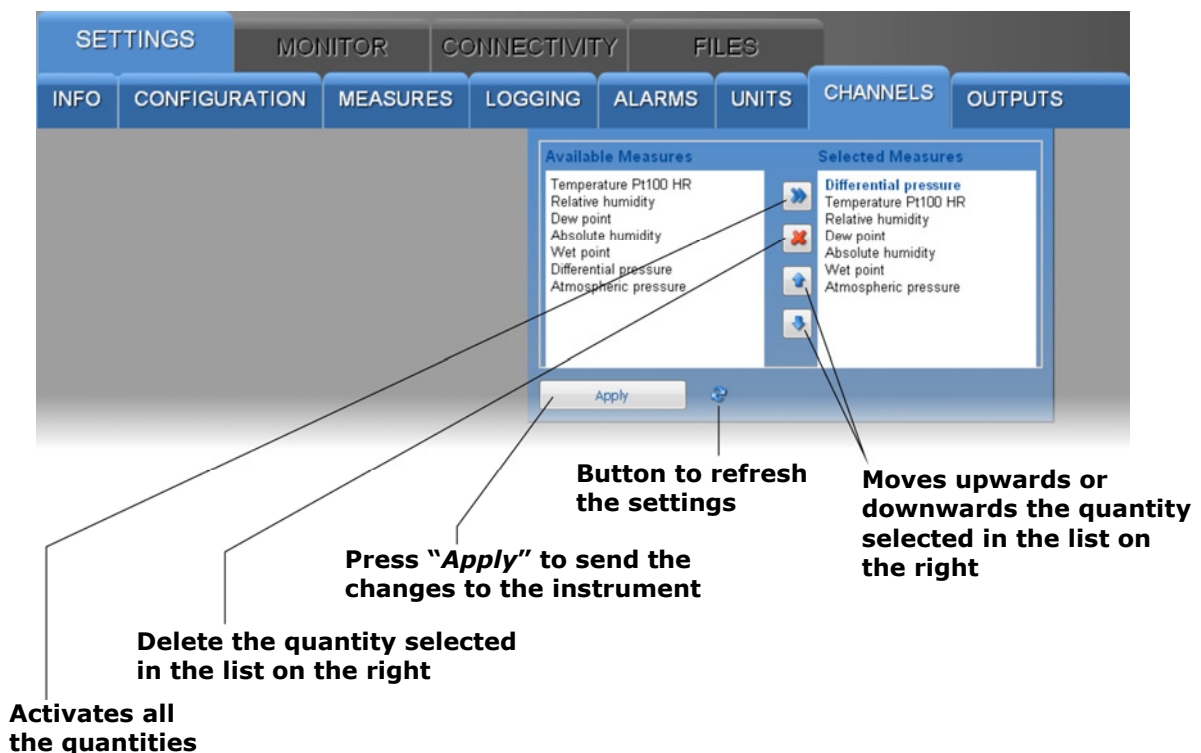

## • OUTPUTS panel

Allows configuring the analog outputs.

SETTINGS MONITOR CONNECTIVITY FILES

INFO CONFIGURATION MEASURES LOGGING ALARMS UNITS CHANNELS OUTPUTS

Analogue Output	Name	Low range value	High range value	Current Output	Voltage Output
OUT1	Differential pressure Pa	-125	125	4-20mA	0-10V
OUT2	Temperature Pt100 HR °C	0	100	4-20mA	0-10V
OUT3	Relative humidity %	0	100	4-20mA	0-10V

Apply

Button to refresh the settings

Press "Apply" to send the changes to the instrument

Quantity value corresponding to 20 mA and 5/10 V

Quantity value corresponding to 0/4 mA and 0 V

Selection 0-5 V or 0-10 V

Selection 0-20 mA or 4-20 mA

The three analog outputs are associated with the first three quantities of the list of selected quantities in the *CHANNELS* panel.

## 8.2 MONITOR MENU

The MONITOR menu allows viewing the real time measurements, both in graphic and table form. The measurements and the corresponding date/time are updated at intervals equal to the logging interval. The measurements acquired by the Monitor function can be saved in a log file and exported in CSV format.

### • MEASURES panel

Displays the current value of the quantities (only those selected for logging).

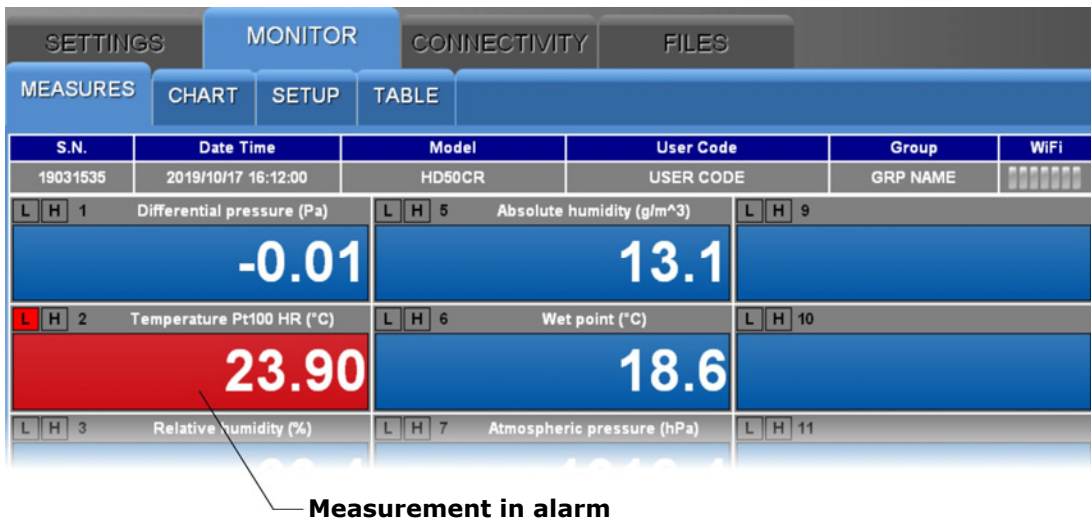

The measurements in alarm are highlighted with a red background. The **L** and **H** symbols indicate whether the lower (L) or higher (H) threshold has been exceeded.

### • CHART panel

Displays the graphs of the measurements acquired by the Monitor function. The quantities can be displayed on the same graph or in separate graphs (see the SETUP panel).

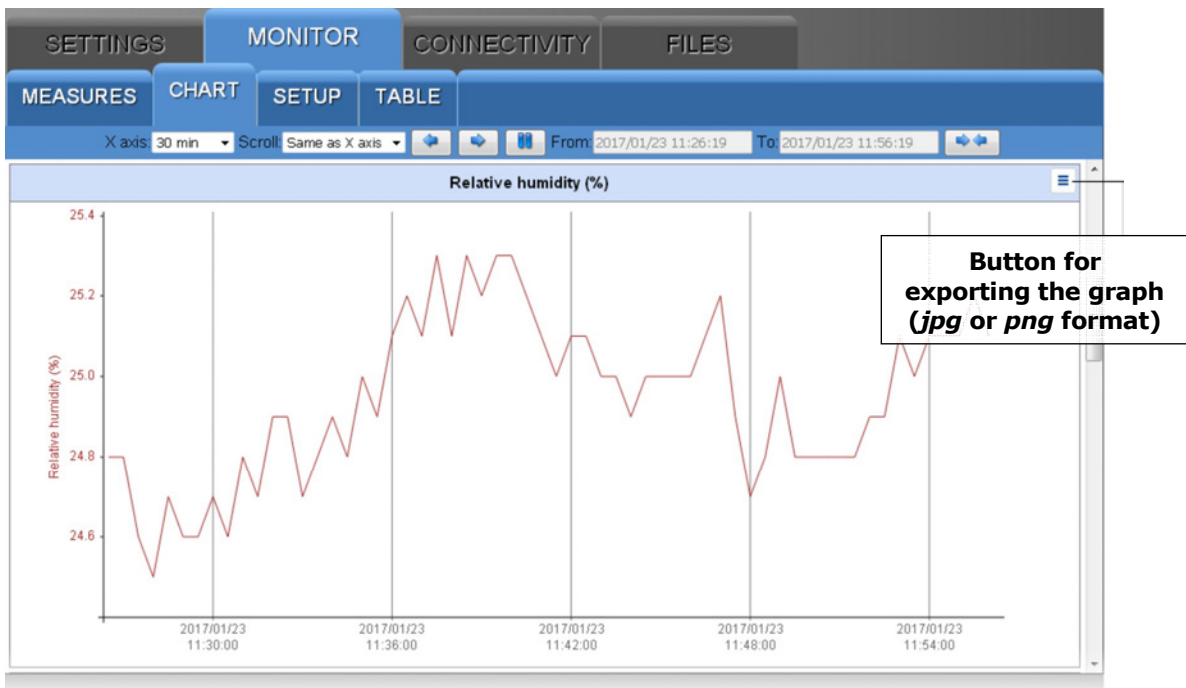

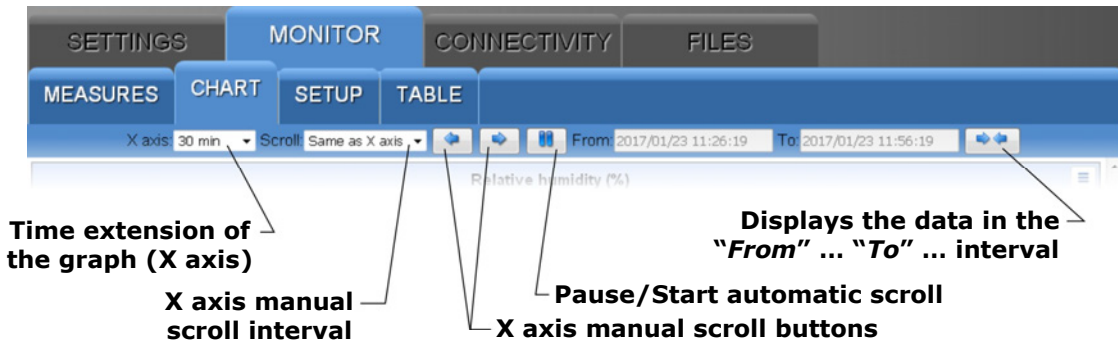

• **SETUP panel**

Setting of the quantities and information to be displayed in the graphs.

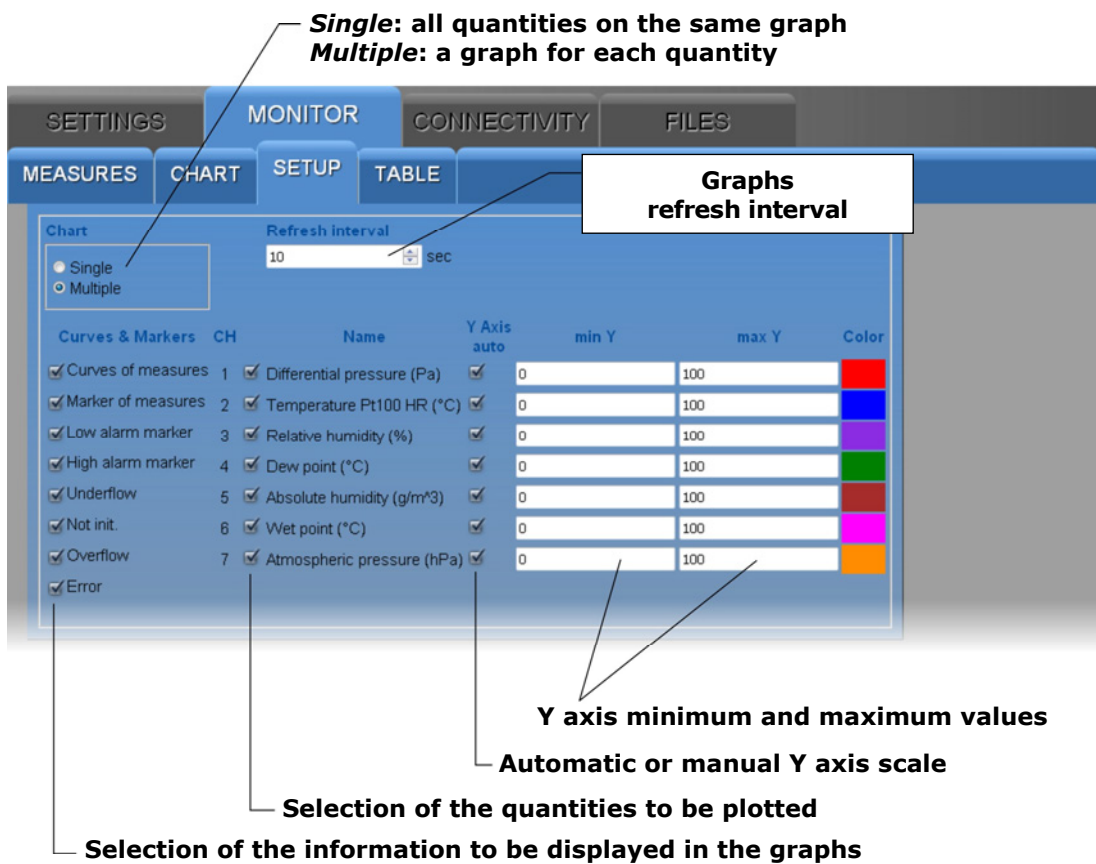

• **TABLE panel**

Displays in numerical form the measurements acquired by the Monitor function.

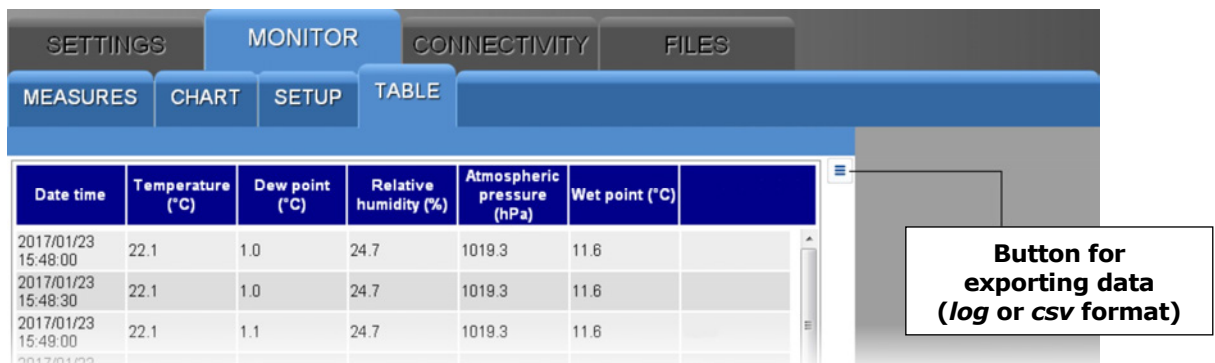

### 8.3 CONNECTIVITY MENU

The CONNECTIVITY menu allows configuring the connection to the local network and the sending of data via e-mail, FTP or to the Cloud (if the network has an Internet connection). It also allows setting the automatic clock synchronization and the time zone.

#### • NETWORK panel

Setting of the network interface type (Wi-Fi or Ethernet), of the protocols, of the TCP/IP ports, of the IP address and of the DNS server address.

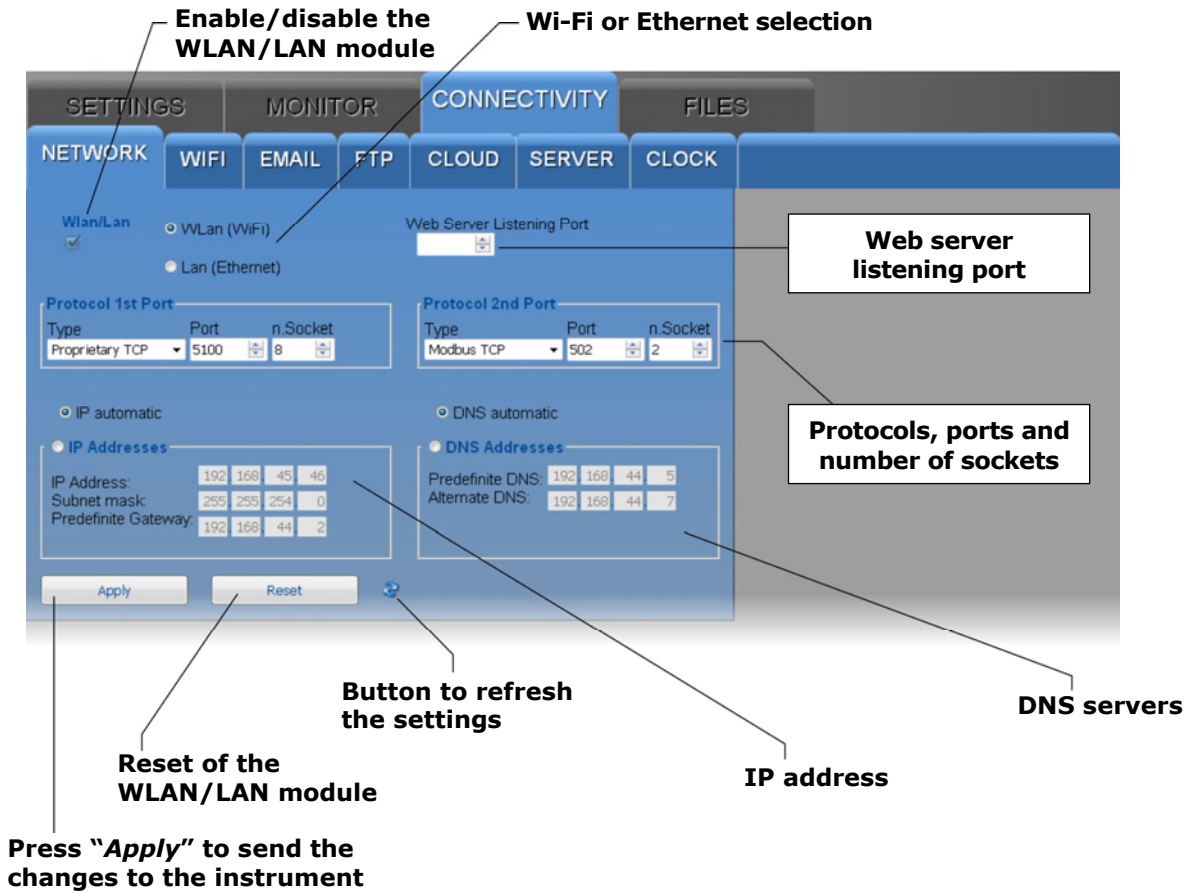

*Note:* if the instrument IP address is changed, the new address must be entered in the web browser to connect to the web server.

If a port number other than the standard HTTP (80) is set as web server listening port, the port number must be specified after the IP address in the web browser. For example, if 40 is set as listening port number of an instrument with IP address 192.168.1.2, in the web browser you need to type 192.168.1.2:40.

The WLAN/LAN module has two TCP/IP ports. For each of the two ports, set the following:

- the *protocol* : select *Proprietary TCP* (proprietary protocol) or *Modbus TCP*.
- the *port number* : the numbers set by default are 5100 for the proprietary protocol and 502 for the Modbus TCP/IP protocol.
- the *number of sockets* of the port : the number of sockets corresponds to the maximum number of connections that can be active at the same time through the port. In total **there are 10 sockets to be divided between the two ports** (for example, if 8 sockets are assigned to the first port, the second port can have a maximum of 2 sockets).



*Note:* if the communication with the Cloud or the HDServer1 is used, the maximum number of "clients" with proprietary or **MODBUS TCP/IP** protocol is nine.

*Note:* actually, the number of MODBUS TCP/IP connections that can be active at the same time is equal to the set number of sockets less one, because a socket is always kept free to accept new connection requests (if all the sockets are active, the socket corresponding to the oldest request is released when a new connection is accepted).

**WARNING: if the WLAN/LAN module configuration is changed, the new settings are not immediately activated, but only after the reset of the module. To immediately activate the new settings, press *Reset*.**

Enter the IP address manually (**static IP** address) or select "*IP automatic*" to obtain the address automatically (**dynamic IP** address) via DHCP protocol (Dynamic Host Configuration Protocol).

*Note:* it is suggested to use a static IP for the communication with the HD35AP-S software, with a web browser or via MODBUS TCP/IP protocol, because the client devices (PC, PLC, ...) do not automatically detect any changes in the IP address of the instrument.

Similarly, select whether to manually enter the addresses of the **DNS** (Domain Name System) **servers** or obtain the server address automatically.

To set the properties in the NETWORK panel you should consult the local network administrator.

- **WIFI panel** (Wi-Fi functionality is optional)

List of the Wi-Fi networks to which the instrument connects. For each network, the network name (SSID), the security protocol (WEP64, WEP128, WAP, WAP2 or none) and the password to access the network must be entered.

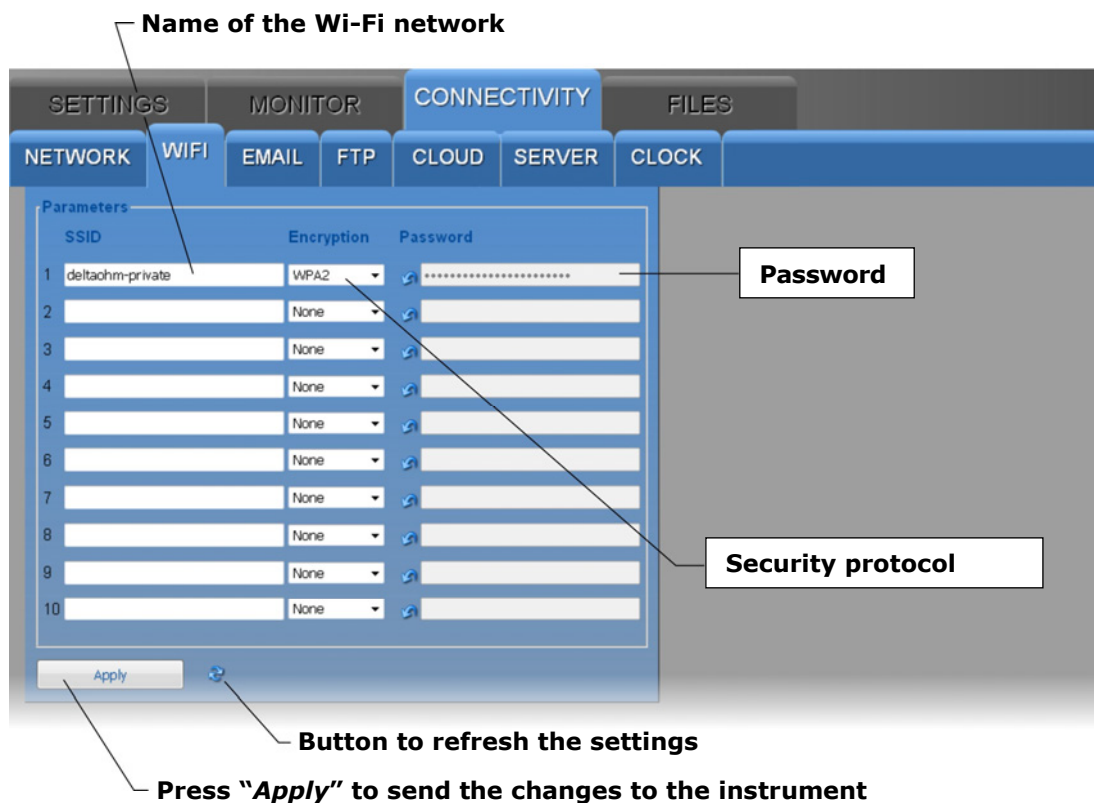

## • EMAIL panel

Setting of the e-mail account used to send data and alarms via e-mail, of the e-mail addresses of the recipients and of the e-mail data uploading modes.

The data can be sent automatically at regular intervals or you can manually request the data memorized within a determined interval of time. The data can be uploaded in *LOG* (for entering in the database and displaying with the Monitor function of the web server) and/or *CSV* (for importing in Excel®) format.

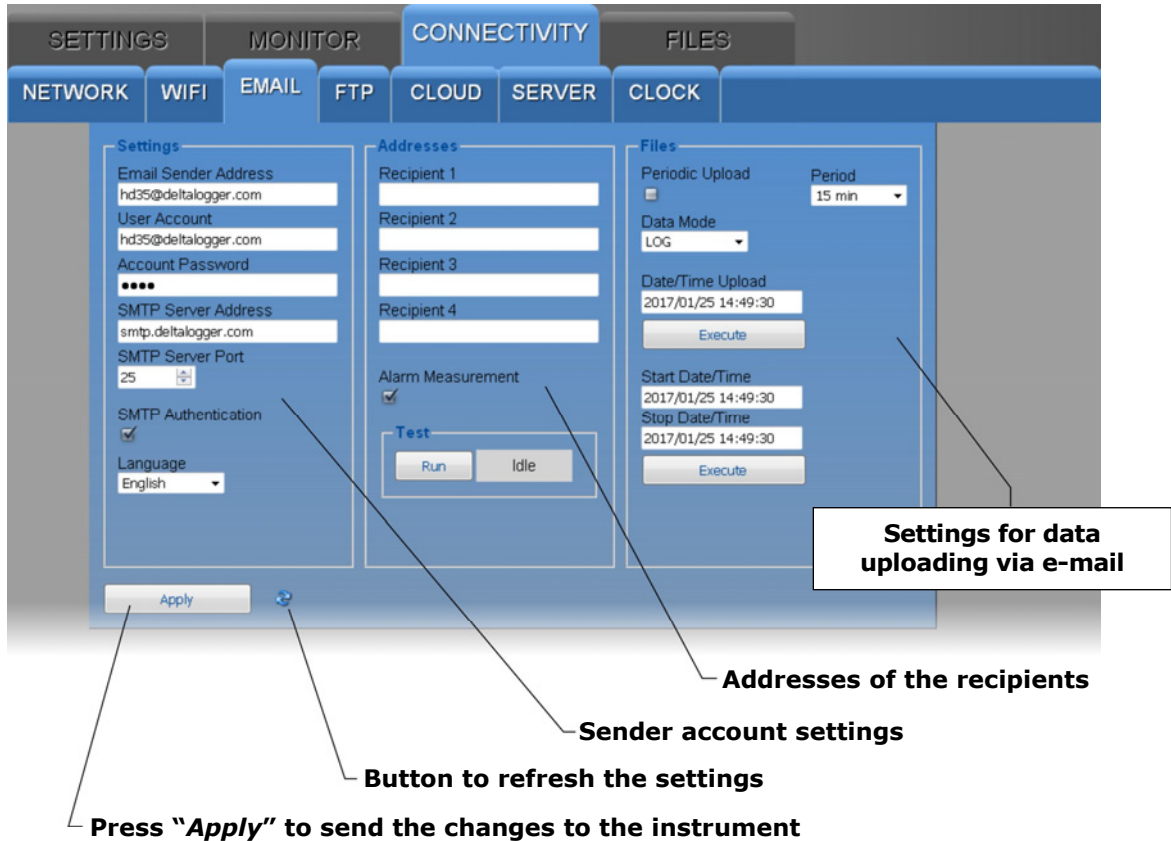

The *Settings* section of the EMAIL panel consists of the following fields:

- *Email Sender Address* : enter the e-mail address of the account that will be used to send the e-mails, that address is what will appear as the sender of the e-mails sent to the recipients.
- *User Account* : enter the user name of the account.
- *Account Password* : enter the password of the account.
- *SMTP Server Address* : enter the outgoing mail server name supplied by your e-mail service provider.
- *SMTP Server Port* : enter the outgoing mail server port number supplied by your e-mail service provider (standard=25).
- *SMTP Authentication* : select the checkbox in order to authenticate e-mails sent.
- *Language* : select the language to be used for sending e-mails.

In the *Addresses* section of the EMAIL panel enter the e-mail addresses of the recipients (*Recipient 1, 2, 3* and *4*). To enable the sending of alarm e-mails, select the *Alarm Measurement* check box. Press the *Run* key to send a test e-mail to the entered recipients; the box next to the *Run* key displays the progress of the test and the final result.



In the *Files* section of the EMAIL panel:

- Select the *Periodic Upload* check box to enable the periodic sending of data via e-mail, then choose the data sending interval in the *Period* field. The available intervals are: 15 min (default), 30 min, 1 hour, 2 hours, 4 hours, 8 hours, 12 hours, 1 day, 2 days, 4 days, 1 week.
- In the *Data Mode* field, select the format of the data sent via e-mail (*LOG*=format for the database and displaying with the Monitor function of the web server, *CSV*=format for Excel®).
- To require the sending via e-mail of all the data memorized subsequently to a given instant, indicate the instant in the *Date/Time Upload* field and press *Execute*.
- To require the sending via e-mail of all data memorized in a determined interval of time, indicate the interval starting instant in the *Start Date/Time* field and the interval ending instant in the *Stop Date/Time* field, then press *Execute*.

**Note: sending e-mail and MODBUS TCP/IP communication are mutually exclusive activities. The e-mails are not sent if a MODBUS TCP/IP communication is active.**

**Note: only SMTP protocol is supported and not SMTPs (SMTP over SSL/TLS).**

#### • FTP panel

Setting of the FTP server and of the FTP data uploading modes.

The data can be sent automatically at regular intervals or you can manually request the data memorized within a determined interval of time. The data can be uploaded in *LOG* (for entering in the database and displaying with the Monitor function of the web server) and/or *CSV* (for importing in Excel®) format.

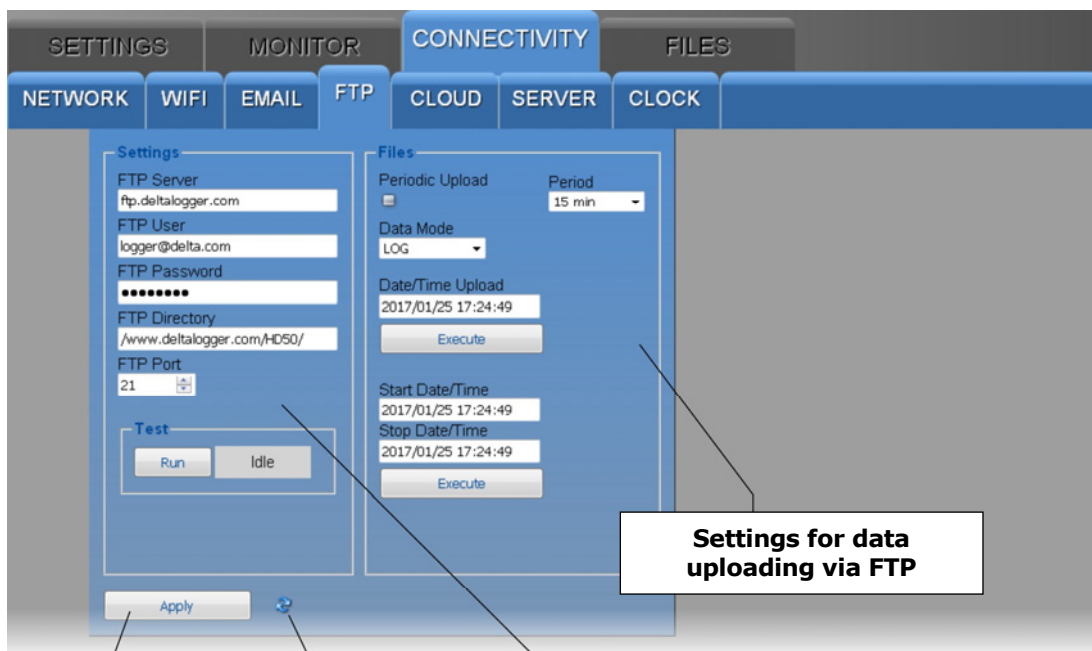

FTP server settings

Button to refresh the settings

Press "Apply" to send the changes to the instrument

The *Settings* section of the FTP panel consists of the following fields:

- *FTP Server* : enter the FTP server name supplied by the service provider.
- *FTP User* : enter the user name to access the FTP service.
- *FTP Password* : enter the password for the FTP service.
- *FTP Directory* : enter the path of the folder in the FTP server where the files coming from the instrument will be transferred.
- *FTP Port* : enter the FTP server port number supplied by the service provider (standard=21).

Press the *Run* key to send a test file via FTP; the box next to the *Run* key displays the progress of the test and the final result.

In the *Files* section of the FTP panel:

- Select the *Periodic Upload* check box to enable the periodic sending of data via FTP, then choose the data sending interval in the *Period* field. The available options are: Real Time, 15 min (default), 30 min, 1 hour, 2 hours, 4 hours, 8 hours, 12 hours, 1 day, 2 days, 4 days, 1 week.
- In the *Data Mode* field, select the format of the data sent via FTP (*LOG*=format for the database and displaying with the Monitor function of the web server, *CSV*=format for Excel®).
- To require the sending via FTP of all the data memorized subsequently to a given instant, indicate the instant in the *Date/Time Upload* field and press *Execute*.
- To require the sending via FTP of all data memorized in a determined interval of time, indicate the interval starting instant in the *Start Date/Time* field and the interval ending instant in the *Stop Date/Time* field, then press *Execute*.

## • CLOUD panel

Setting of the Cloud and of the Cloud data uploading modes.

The data can be uploaded to the Cloud automatically at regular intervals or you can manually request the data memorized within a determined interval of time. The data are sent using the Cloud Delta OHM protocol.

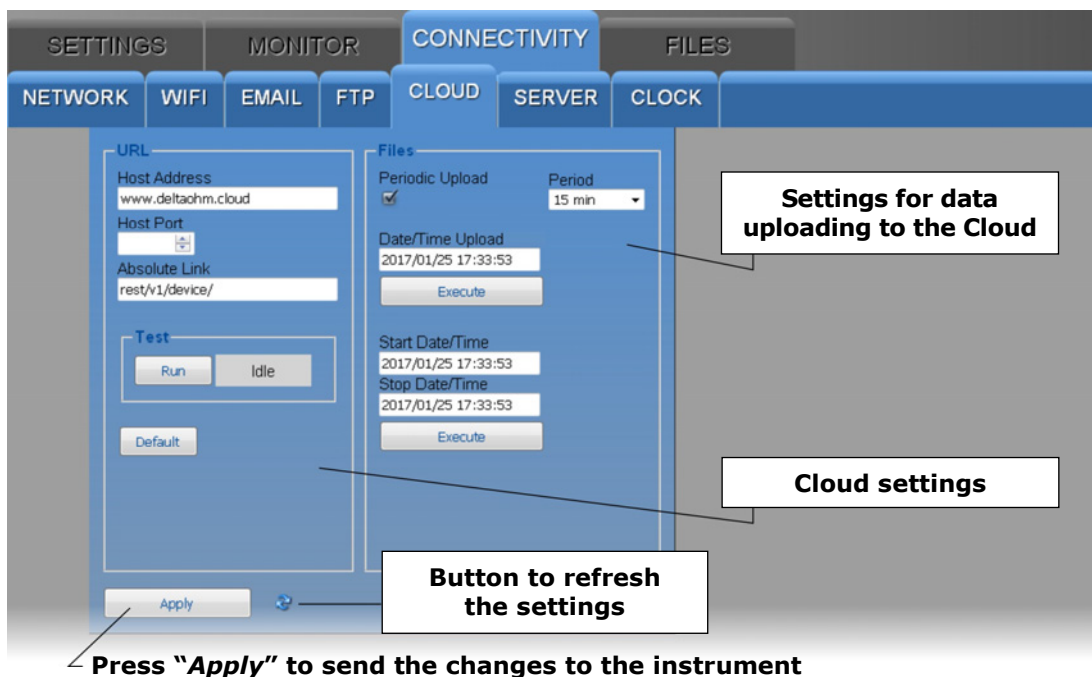

The *URL* section of the CLOUD panel consists of the following fields:

- *Host Address* : enter the Cloud name supplied by the service provider (for ex. "www.deltaohm.cloud").
- *Host Port* : enter the server port number supplied by the service provider (if the standard HTTP port 80 is used, it is not necessary to indicate it).
- *Absolute Link* : enter the path in the server where the data coming from the instrument will be uploaded.

Press the *Run* key to test the sending of data to the Cloud; the box next to the *Run* key displays the progress of the test and the final result.

The *Default* key restores the factory settings for the Cloud.

In the *Files* section of the CLOUD panel:

- Select the *Periodic Upload* check box to enable the periodic sending of data to the Cloud, then choose the data sending interval in the *Period* field. The available options are: Real Time, 15 min (default), 30 min, 1 hour, 2 hours, 4 hours, 8 hours, 12 hours, 1 day, 2 days, 4 days, 1 week.
- To require the sending to the Cloud of all the data memorized subsequently to a given instant, indicate the instant in the *Date/Time Upload* field and press *Execute*.
- To require the sending to the Cloud of all data memorized in a determined interval of time, indicate the interval starting instant in the *Start Date/Time* field and the interval ending instant in the *Stop Date/Time* field, then press *Execute*

## • SERVER panel

Setting of the IP address of the PC in which the server function of the **HDServer1** software is active and to which the data can be sent for storage into the database.

The data can be uploaded to the server automatically at regular intervals or you can manually request the data memorized within a determined interval of time.

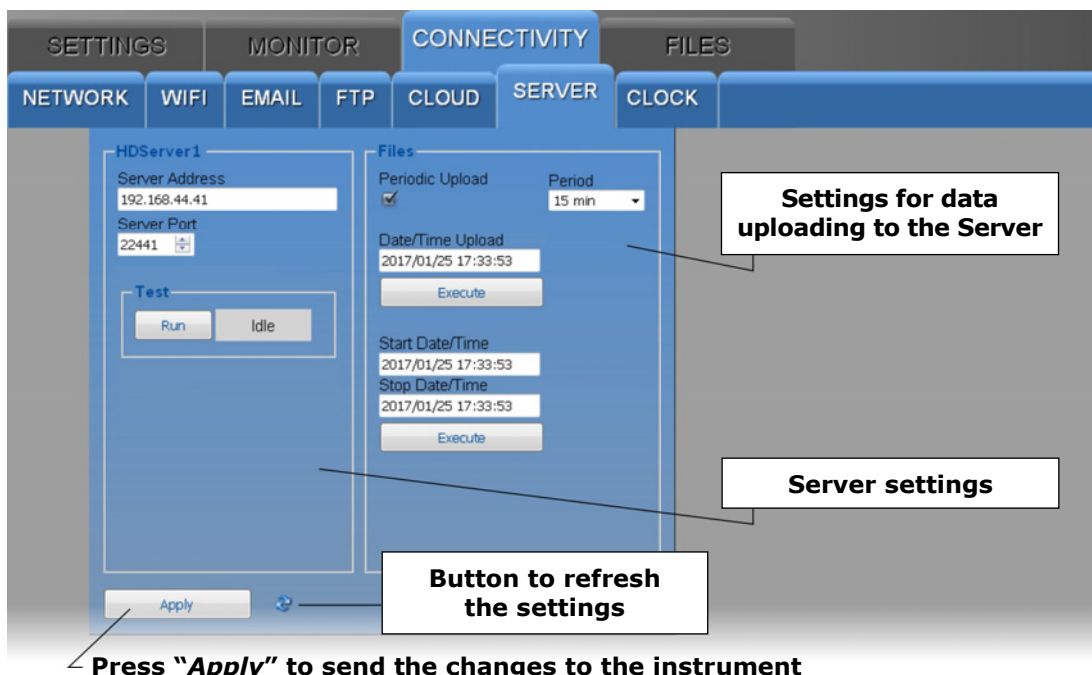

The *HDServer1* section of the SERVER panel consists of the following fields:

- *Server Address* : enter the IP address of the PC in which the server function of the HDServer1 software is active.
- *Server Port* : enter the port number of the PC in which the server function of the HDServer1 software is active.

Press the *Run* key to test the communication with the HDServer1 software; the box next to the *Run* key displays the progress of the test and the final result.

In the *Files* section of the SERVER panel:

- Select the *Periodic Upload* check box to enable the periodic sending of data to the HDServer1 software, then choose the data sending interval in the *Period* field. The available options are: Real Time (default), 15 min, 30 min, 1 hour, 2 hours, 4 hours, 8 hours, 12 hours, 1 day, 2 days, 4 days, 1 week.
- To require the sending to the HDServer1 software of all the data memorized subsequently to a given instant, indicate the instant in the *Date/Time Upload* field and press *Execute*.
- To require the sending to the HDServer1 software of all data memorized in a determined interval of time, indicate the interval starting instant in the *Start Date/Time* field and the interval ending instant in the *Stop Date/Time* field, then press *Execute*

## • CLOCK panel

Setting of clock synchronization and time zone.

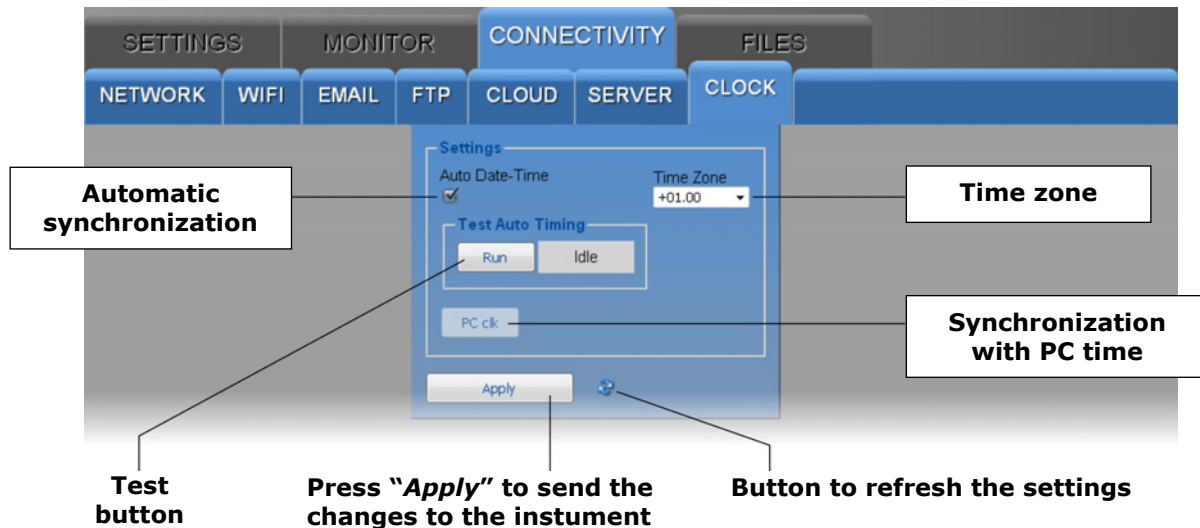

Select the *Auto Date-Time* check box to keep the clock synchronized with a NIST reference server (if the instrument is connected to the local network and the Internet connection is available). Press the *Run* key to check the automatic synchronization; the box next to the *Run* key displays the progress of the test and the final result.

To set the clock with the PC date and time, deselect the *Auto Date-Time* check box and press the *PC clk* key.

If the *Auto Date-Time* check box is unchecked but communication with the HDServer1 software is active, the clock is kept synchronized with the time of the PC in which the HDServer1 software is running.

## 8.4 FILES MENU

---

The FILES menu allows importing and viewing the files with the data sent by the instrument via e-mail and/or FTP, or the data acquired in the past with the MONITOR function of the web server and saved in the PC, tablet or smartphone.

### • LOAD panel

Select the files with the data to be imported.

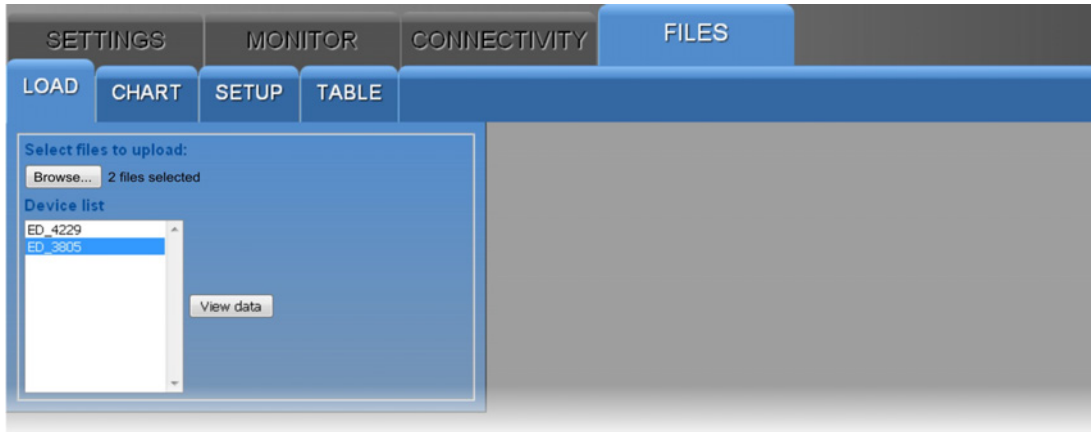

Press the *Browse...* key and select the files to be imported (multiple files can be selected). The instrument corresponding to the imported files appear in the *Device list*: select an instrument and press *View data* to display the data.

### • CHART panel

Displays the graphs of the imported measurements. See the CHART panel of the MONITOR menu.

### • SETUP panel

Setting of the quantities and information to be displayed in the graphs of the imported measurements. See the SETUP panel of the MONITOR menu.

### • TABLE panel

Displays numerically the imported measurements. See the TABLE panel of the MONITOR menu.

## 9 MENU

The menu accessible via the front keyboard allows displaying the instrument information and changing operating parameters. The menu is structured in levels, with main categories and submenus.

To access the menu, you need to enter the **user password** (configurable through the appropriate menu item) or the **administrator password** (supplied with the instrument and not editable). Entering the user password makes some settings not changeable.

The instrument exits automatically the menu if no key is pressed for 3 minutes. After exiting the menu, the password remains active for a few minutes, during which you may enter the menu again without re-entering the password. It is possible to exit the menu by disabling immediately the password by performing a password level reset in the *Password* menu.

To access a menu parameter, proceed as follows:

1. Press **MENU**, the first digit of the password will blink.
2. Using  $\blacktriangledown/\blacktriangle$  keys, set the first digit and confirm (**MENU/↵** key), the second digit of the password will blink. Set the remaining digits in the same way.
3. Using  $\blacktriangledown/\blacktriangle$  keys, select a main category in the menu and confirm (**MENU/↵** key).
4. If the selected main category has a submenu, select the desired item using  $\blacktriangledown/\blacktriangle$  keys and confirm (**MENU/↵** key).
5. Using  $\blacktriangledown/\blacktriangle$  keys, select the desired parameter: the parameter current setting is displayed.
6. To change the selected parameter, if allowed, press **MENU/↵**, the parameter setting blinks. Use  $\blacktriangledown/\blacktriangle$  keys to change the setting, then confirm (**MENU/↵** key). You can fast forward by keeping  $\blacktriangledown$  or  $\blacktriangle$  key depressed.

To exit the main menu or a sub menu, press ESC key.

If it is not allowed to change a parameter, the notice N/A (Not Available) will appear when trying to change it.

### Menu main category

**F100** (DEV INFO): instrument general information

**F200** (MEAS MENU): selection of the quantities to be detected

**F300** (DISP LOOP VIEW): selection of the quantities to be displayed cyclically

**F400** (ALRM MENU): setting of the alarms

**F500** (UNIT MEAS MENU): units of measurement

**F600** (LOG MENU): logging settings

**F700** (AN OUT MENU): setting of the analog outputs

**F800** (LAN MENU): LAN/WLAN settings

**F900** (MODBUS MENU): Modbus settings

**FA00** (CLK MENU): clock settings

**Fb00** (PSW MENU): password settings

**FC00** (CAL MENU): calibration settings

### **F100 submenu** (DEV INFO)

Instrument general information.

- F101:** model
- F102:** serial number
- F103:** user code
- F104:** group name
- F105:** firmware version
- F106:** firmware date
- F107:** factory calibration date
- F108:** user calibration date
- F109:** type of calibration in use (factory or user)
- F110:** external probe serial number

### **F200 submenu** (MEAS MENU)

Selection and sorting of the quantities to be detected.

- F201:** temperature measurement index {CH1...CH6, default=CH2}
- F202:** relative humidity measurement index {CH1...CH6, default=CH3}
- F203:** Dew Point measurement index {CH1...CH6, default=CH4}
- F204:** Absolute humidity measurement index {CH1...CH6, default=CH5}
- F205:** Wet bulb temperature measurement index {CH1...CH6, default=CH6}
- F206:** differential pressure measurement index {CH1...CH6, default=CH1}

Set a measurement to *OFF* to exclude it.

### **F300 submenu** (DISP LOOP VIEW)

Selection of the quantities to be displayed cyclically.

*Note:* in the F300 submenu, only the quantities to be detected appear, in the order set in the F200 submenu.

- F301:** quantity of index 1 {On/OFF, default=On}
- F302:** quantity of index 2 {On/OFF, default=On}
- F303:** quantity of index 3 {On/OFF, default=On}
- F304:** quantity of index 4 {On/OFF, default=On}
- F305:** quantity of index 5 {On/OFF, default=On}
- F306:** quantity of index 6 {On/OFF, default=On}

Set a measurement to *OFF* to exclude it from the cyclical display.

### **F400 submenu** (ALRM MENU)

Setting of the alarms.

*Note:* in the F400 submenu, the quantities appear in the order set in the F200 submenu.

- F408:** period, in seconds, of the beep emitted by the buzzer {1...3600, default=2}
- F409:** duration, in seconds, of the beep emitted by the buzzer {0.1...20, default=1.0}
- F410: alarm of the quantity of index 1**
  - F411:** lower alarm threshold

- F412:** lower alarm threshold enabling {On/OFF, default=On}
- F413:** upper alarm threshold
- F414:** upper alarm threshold enabling {On/OFF, default=On}
- F415:** alarm hysteresis in % of the difference between the two alarm thresholds {0...100 %, default=2%}
- F416:** delay time in signaling the alarm {max. 960 min, default=0}
- F417:** buzzer enabling {On/OFF, default=OFF}
- F418:** buzzer "Latch" function enabling {On/OFF, default=OFF}
- F419:** buzzer silencing time, in minutes {0...1080, default=0}

.  
.  
.

#### **F460: alarm of the quantity of index 6**

- F461:** lower alarm threshold
- F462:** lower alarm threshold enabling {On/OFF, default=On}
- F463:** upper alarm threshold
- F464:** upper alarm threshold enabling {On/OFF, default=On}
- F465:** alarm hysteresis in % of the difference between the two alarm thresholds {0...100 %, default=2%}
- F466:** delay time in signaling the alarm {max. 960 min, default=0}
- F467:** buzzer enabling {On/OFF, default=OFF}
- F468:** buzzer "Latch" function enabling {On/OFF, default=OFF}
- F469:** buzzer silencing time, in minutes {0...1080, default=0}

#### **F500 submenu** (UNIT MEAS MENU)

Units of measurement.

- F501:** temperature unit of measurement {°C/°F, default=°C}
- F502:** differential pressure unit of measurement {hPa / kPa / atm / mmHg / mmH<sub>2</sub>O / inHg / inH<sub>2</sub>O / (kgf /cm<sup>2</sup>) / PSI / mbar / bar / Pa, default=hPa}

#### **F600 submenu** (LOG MENU)

Logging settings.

- F601:** logging enabling/disabling {On/OFF, default=On}
- F602:** choice between cyclical management (the new data overwrite the old ones when the memory is full) or non-cyclical management (logging stops when the memory is full) of the instrument internal memory {YES=cyclical management / NO=non-cyclical management, default=YES}
- F603:** logging interval (if it is higher than the measuring interval, the average of the measurements acquired during the interval will be stored) {default=30 s}
- F604:** measurements acquisition interval {default=1 s}. If a value higher than the logging interval is set, the measurements will be detected with interval equal to the logging interval.
- F605:** deletion of all stored measurements from the instrument memory {YES/nO}



## **F700 submenu** (AN OUT MENU)

Setting of the analog outputs.

### **F710: analog output 1**

**F711:** 0-20 mA / 4-20 mA selection for the current output {default=4-20 mA}

**F712:** 0-5 V / 0-10 V selection for the voltage output {default=0-10 V}

**F713:** value of the quantity associated with the analog output corresponding to 0/4 mA and 0 V {default=-125 Pa}

**F714:** value of the quantity associated with the analog output corresponding to 20 mA and 5/10 V {default=+125 Pa}

**F715:** analog output test mode. The current output goes to the value entered. Set OFF to exit the test mode.

**F716:** analog output test mode. The voltage output goes to the value entered. Set OFF to exit the test mode.

### **F720: analog output 2**

**F721:** 0-20 mA / 4-20 mA selection for the current output {default=4-20 mA}

**F722:** 0-5 V / 0-10 V selection for the voltage output {default=0-10 V}

**F723:** value of the quantity associated with the analog output corresponding to 0/4 mA and 0 V {default=0.0 °C}

**F724:** value of the quantity associated with the analog output corresponding to 20 mA and 5/10 V {default=100.0 °C}

**F725:** analog output test mode. The current output goes to the value entered. Set OFF to exit the test mode.

**F726:** analog output test mode. The voltage output goes to the value entered. Set OFF to exit the test mode.

### **F730: analog output 3**

**F731:** 0-20 mA / 4-20 mA selection for the current output {default=4-20 mA}

**F732:** 0-5 V / 0-10 V selection for the voltage output {default=0-10 V}

**F733:** value of the quantity associated with the analog output corresponding to 0/4 mA and 0 V {default=0.0 %RH}

**F734:** value of the quantity associated with the analog output corresponding to 20 mA and 5/10 V {default=100.0 %RH}

**F735:** analog output test mode. The current output goes to the value entered. Set OFF to exit the test mode.

**F736:** analog output test mode. The voltage output goes to the value entered. Set OFF to exit the test mode.

## **F800 submenu** (LAN MENU)

LAN/WLAN settings.

**F801:** WLAN/LAN module reset {YES/nO}. **if the WLAN/LAN module configuration is changed, the new settings are not immediately activated, but only after the reset of the module. To immediately activate the new settings, set this parameter to YES.**

**F802:** set the default configuration of the WLAN/LAN module {YES/nO, default=nO}

**F803:** enable the sending of alarm e-mail {On/OFF, default=On}

**F804:** enable the sending of data via e-mail {On/OFF, default=OFF}

- F805:** sending interval of the of data via e-mail {Real time / 15 min / 30 min / 1 hour / 2 hours / 4 hours / 8 hours / 12 hours / 1 day / 2 days / 4 days / 1 week, default=15 min}
- F806:** format of the data sent via e-mail {LOG=format for the database and displaying with the Monitor function of the web server, CSV=format for Excel®, default=LOG}
- F807:** enable the sending of data via FTP {On/OFF, default=OFF}
- F808:** sending interval of the of data via FTP {Real time / 15 min / 30 min / 1 hour / 2 hours / 4 hours / 8 hours / 12 hours / 1 day / 2 days / 4 days / 1 week, default=15 min}
- F809:** format of the data sent via FTP {LOG=format for the database and displaying with the Monitor function of the web server, CSV=format for Excel®, default=LOG}
- F810:** enable the sending of data to the Cloud {On/OFF, default=OFF}
- F811:** sending interval of the of data to the Cloud {Real time / 15 min / 30 min / 1 hour / 2 hours / 4 hours / 8 hours / 12 hours / 1 day / 2 days / 4 days / 1 week, default=15 min}
- F812:** enable the sending of data to the PC in which the server function of the HDServer1 software is active {On/OFF, default=OFF}
- F813:** sending interval of the of data to the PC in which the server function of the HDServer1 software is active {Real time / 15 min / 30 min / 1 hour / 2 hours / 4 hours / 8 hours / 12 hours / 1 day / 2 days / 4 days / 1 week, default=15 min}

**F900 submenu** (MODBUS MENU)

Modbus settings.

- F901:** Modbus address {1...247, default=1}
- F902:** RS485 baud rate in kbps {9.6 / 19.2 / 38.4 / 57.6 / 115.2, default=19.2}
- F903:** RS485 communication mode {8N1 / 8N2 / 8E1 / 8E2 / 8O1 / 8O2, default=8E1}
- F904:** waiting of 3.5 characters after transmission with Modbus protocol {nO=violate protocol and go in receiving mode right after transmission / YES=respect protocol and wait 3.5 characters after transmission, default=nO}
- F905:** enabling of the password for changing the configuration via Modbus {On/OFF, default=OFF}

**FA00 submenu** (CLK MENU)

Clock settings.

- FA01:** year
- FA02:** month
- FA03:** day
- FA04:** hour
- FA05:** minutes
- FA06:** enabling of the automatic synchronization of the internal clock with a reference server {On/OFF, default=OFF}
- FA07:** time zone {default=0}

### **Fb00 submenu** (PSW MENU)

Password settings.

**Fb01:** exits the menu and deactivates immediately the password {YES/nO}. The password will not remain active for some minutes as it normally happens when exiting the menu: you will need to re-enter the password even if you re-access immediately the menu.

**Fb02:** setting of the user-level password {default=0000}

**Fb03:** locking of the instrument keyboard {YES/nO, default=nO}. If the keyboard is locked, keep the **MENU/↵** key pressed for 7 seconds to unlock it.

### **FC00 submenu** (CAL MENU)

Calibration settings.

**FC03:** relative humidity sensor calibration at 75%RH

**FC04:** relative humidity sensor calibration at 33%RH

**FC05:** differential pressure calibration at zero

**FC06:** enabling of the differential pressure auto-calibration at zero {On/OFF, default=On}

**FC07:** interval, in minutes, of the differential pressure auto-calibration at zero {5...360, default=60}

**FC08:** differential pressure second calibration point (in Pa)

**FC09:** reset of the differential pressure second calibration point

**FC10:** type of calibration used {FACT=factory / USEr=user, default=FACT}

## 10 MODBUS

The device general information can be read through the function code **0x2B/0x0E**:

- Manufacturer (Delta OHM)
- Model
- Firmware version

The complete list of MODBUS registers is shown below. If you try to read a register that is not present, the instrument returns the fixed value 32767. The list of the available registers can be downloaded in the PC using the function " *Download the list of MODBUS registers of the device* " included in the *Settings* sections of HD35AP-S software (see software instructions).

The following conventions have been used in the tables:

- Type: **b** = bit, **B** = 8 bits (Byte), **W** = 16 bits without sign (Word), **SW** = 16 bits with sign
- **(x10)** = decimal value expressed as an integer (e.g., if the content of the register is 184, the value is to be intended as 18,4).
- **(x100)** = centesimal value expressed as an integer (e.g., if the content of the register is 500, the value is to be intended as 5,00).

The commands for requesting units of measurement return an index according to the correspondence indicated in the table below:

### Indexes of the units of measurement

Index	Unit of meas.	Index	Unit of meas.	Index	Unit of meas.	Index	Unit of meas.	Index	Unit of meas.
0	°C	13	inchHg	26	J/m <sup>2</sup>	39	inch	52	l/min
1	°F	14	inchH <sub>2</sub> O	27	μJ/cm <sup>2</sup>	40	counts	53	gallon/min
2	%UR	15	kgf/cm <sup>2</sup>	28	V	41	mm/h	54	m <sup>3</sup> /min
3	g/m <sup>3</sup>	16	PSI	29	mV	42	inch/h	55	m <sup>3</sup> /h
4	g/kg	17	m/s	30	mA	43	counts/h	56	μmol/(m <sup>2</sup> s)
5	mbar	18	km/h	31	ppm	44	mW/m <sup>2</sup>	57	mm/day
6	bar	19	ft/s	32	Hz	45	m	58	kV
7	Pa	20	mph	33	%	46	s	59	A
8	hPa	21	knot	34	degrees	47	μW/lumen	60	kA
9	kPa	22	W/m <sup>2</sup>	35	lux	48	dB		
10	atm	23	μW/cm <sup>2</sup>	36	m <sup>2</sup> /s	49	dBA		
11	mmHg	24	Wh/m <sup>2</sup>	37	g (*)	50	kWh		
12	mmH <sub>2</sub> O	25	kWh/m <sup>2</sup>	38	mm	51	l/s	255	Not defined

(\*) Gravity acceleration

### Discrete Inputs - Read-only parameters

Address	Type	Discrete Input description
7	b	If 1, at least a quantity is in alarm.

## Coils - Read/Write parameters

Address	Type	Coil description
0	b	Receiving mode after transmission with Modbus protocol: 0=violate protocol and go in receiving mode right after transmission 1=respect protocol and wait 3.5 characters after transmission
1	b	Logging status: 0=active, 1=inactive
2	b	Logging mode: 0=non cyclic, 1=cyclic
3	b	Set 1 to delete the device logging memory. Bit zeroing is automatic.
9	b	Protection of configuration with password: 0=no, 1=yes Changing the parameter requires the Administrator password (see Holding Register 10036).
23	b	Enabling of the lower alarm threshold for the quantity #1: 0= disabled, 1= enabled
24	b	Enabling of the lower alarm threshold for the quantity #2: 0= disabled, 1= enabled
25	b	Enabling of the lower alarm threshold for the quantity #3: 0= disabled, 1= enabled
26	b	Enabling of the lower alarm threshold for the quantity #4: 0= disabled, 1= enabled
27	b	Enabling of the lower alarm threshold for the quantity #5: 0= disabled, 1= enabled
28	b	Enabling of the lower alarm threshold for the quantity #6: 0= disabled, 1= enabled
35	b	Enabling of the upper alarm threshold for the quantity #1: 0= disabled, 1= enabled
36	b	Enabling of the upper alarm threshold for the quantity #2: 0= disabled, 1= enabled
37	b	Enabling of the upper alarm threshold for the quantity #3: 0= disabled, 1= enabled
38	b	Enabling of the upper alarm threshold for the quantity #4: 0= disabled, 1= enabled
39	b	Enabling of the upper alarm threshold for the quantity #5: 0= disabled, 1= enabled
40	b	Enabling of the upper alarm threshold for the quantity #6: 0= disabled, 1= enabled
47	b	Enabling of the buzzer for the quantity #1: 0= disabled, 1=enabled
48	b	Enabling of the buzzer for the quantity #2: 0= disabled, 1=enabled
49	b	Enabling of the buzzer for the quantity #3: 0= disabled, 1=enabled
50	b	Enabling of the buzzer for the quantity #4: 0= disabled, 1=enabled
51	b	Enabling of the buzzer for the quantity #5: 0= disabled, 1=enabled
52	b	Enabling of the buzzer for the quantity #6: 0= disabled, 1=enabled
59	b	Enabling of the buzzer "Latch" function for the quantity #1: 0= disabled, 1=enabled
60	b	Enabling of the buzzer "Latch" function for the quantity #2: 0= disabled, 1=enabled
61	b	Enabling of the buzzer "Latch" function for the quantity #3: 0= disabled, 1=enabled
62	b	Enabling of the buzzer "Latch" function for the quantity #4: 0= disabled, 1=enabled
63	b	Enabling of the buzzer "Latch" function for the quantity #5: 0= disabled, 1=enabled

Address	Type	Coil description
64	b	Enabling of the buzzer "Latch" function for the quantity #6: 0= disabled, 1=enabled
71	b	Type of calibration used: 0=factory, 1=user
72	b	Set 1 to carry out the zero calibration of the differential pressure. Bit zeroing is automatic.
73	b	Enabling of the auto-calibration of the zero of the differential pressure: 0=disabled, 1=enabled

### Input Registers - Read-only parameters

Address	Type	Input Register description
<b>Measured values and status of measurement alarms</b>		
2	SW	<b>RELATIVE HUMIDITY</b> in % (x10).
3	B	Relative humidity alarm: 0=OFF, 1=lower threshold alarm, 2=higher threshold alarm.
4	SW	<b>DEW POINT</b> in the set measurement unit (x10).
5	B	Dew Point alarm: 0=OFF, 1=lower threshold alarm, 2=higher threshold alarm.
10	SW	<b>ABSOLUTE HUMIDITY</b> in g/m <sup>3</sup> (x10).
11	B	Absolute humidity alarm: 0=OFF, 1=lower threshold alarm, 2=higher threshold alarm.
12	SW	<b>WET BULB TEMPERATURE</b> in the set measurement unit (x10).
13	B	Wet bulb temperature alarm: 0=OFF, 1=lower threshold alarm, 2=higher threshold alarm.
84	SW	<b>DIFFERENTIAL PRESSURE</b> in the set measurement unit (the multiplier depends on the set unit).
85	B	Differential pressure alarm: 0=OFF, 1=lower threshold alarm, 2=higher threshold alarm.
174	SW	<b>TEMPERATURE</b> with 4-wire Pt100 sensor of the T/RH combined probe in the set measurement unit (x100).
175	B	Alarm for temperature with 4-wire Pt100 sensor of the T/RH combined probe: 0=OFF, 1=lower threshold alarm, 2=higher threshold alarm.
<b>Measurement units and resolution</b>		
5004	W	<b>DEW POINT</b> measurement unit: 0=°C, 1=°F.
5012	W	<b>WET BULB TEMPERATURE</b> measurement unit: 0=°C, 1=°F.
5084	W	<b>DIFFERENTIAL PRESSURE</b> measurement unit: see the table of indexes
5085	SW	<b>DIFFERENTIAL PRESSURE</b> resolution: ..., -2=100, -1=10, 0=1, 1=0.1, 2=0.01, ...
5174	W	Unit of measurement for <b>TEMPERATURE</b> with 4-wire Pt100 sensor of the T/RH combined probe: 0=°C, 1=°F.
<b>General information</b>		
10000	W	Year of last measurement.
10001	W	Month of last measurement.
10002	W	Day of last measurement.
10003	W	Hour of last measurement.
10004	W	Minutes of last measurement.
10005	W	Seconds of last measurement.
10010	W	Time, in seconds, elapsed since the last transmitted packet.
10011	W	RF signal level.

Address	Type	Input Register description
10013	W	Password level for the current connection: 0=no password, 1=user level, 2= administrator level

### Holding Registers - Read/Write parameters

Address	Type	Holding Register description
<b>Measurement alarm thresholds</b>		
2	SW	<b>RH</b> lower alarm threshold in % (x10).
3	SW	RH higher alarm threshold in % (x10).
4	SW	<b>DEW POINT</b> lower alarm threshold in the set measurement unit (x10).
5	SW	Dew point higher alarm threshold in the set measurement unit (x10).
10	SW	<b>ABSOLUTE HUMIDITY</b> lower alarm threshold in g/m <sup>3</sup> (x10).
11	SW	Absolute humidity higher alarm threshold in g/m <sup>3</sup> (x10).
12	SW	<b>WET BULB TEMPERATURE</b> lower alarm threshold in the set measurement unit (x10).
13	SW	Wet bulb temperature higher alarm threshold in the set measurement unit (x10).
84	SW	<b>DIFFERENTIAL PRESSURE</b> lower alarm threshold in the set measurement unit (the multiplier depends on the set unit).
85	SW	Differential pressure higher alarm threshold in the set measurement unit (the multiplier depends on the set unit).
174	SW	Lower alarm threshold for <b>TEMPERATURE</b> with 4-wire Pt100 sensor of the T/RH combined probe in the set measurement unit (x100).
175	SW	Higher alarm threshold for temperature with 4-wire Pt100 sensor of the T/RH combined probe in the set measurement unit (x100).
<b>General information</b>		
da 10000 a 10019	B	User code with ASCII codification. Acceptable values are in the set {32,...,126}.
10020	W	Current year
10021	W	Current month
10022	W	Current day
10023	W	Current hour
10024	W	Current minute
10025	W	Current second
10026	W	Measurement interval: 0=1s, 1=2s, 2=5s, 3=10s, 4=15s, 5=30s, 6=1min, 7=2min, 8=5min, 9=10min, 10=15min, 11=30min, 12=1h
10027	W	Logging interval: 0=1s, 1=2s, 2=5s, 3=10s, 4=15s, 5=30s, 6=1min, 7=2min, 8=5min, 9=10min, 10=15min, 11=30min, 12=1h
10032	W	Temperature measurement unit: 0=°C, 1=°F
10034	W	Baud rate RS485: 0=9600, 1=19200, 3=38400 bit/s
10035	W	RS485 communication mode: 0=8N1, 1=8N2, 2=8E1, 3=8E2, 4=8O1, 5=8O2
10036	W	Password to be supplied to enable configuration change commands. The reading provides the fixed value 32768.
da 10037 a 10046	B	Device group with ASCII codification. Acceptable values are in the set {32,...,126}.
10049	W	Differential pressure unit of measurement: see the table of indexes

Address	Type	Holding Register description
10052	W	Setting of the quantities to be displayed in the automatic viewing cycle. Set the i-th bit (starting from LSB) to 1 if you wish to include the i-th quantity in the viewing cycle. <i>Example:</i> if 1=Temp., 2=RH, 3=Td, 4=Diff.Press., 5=AH, 6=Tw, the register is set to 0000 0000 0001 0010, only the relative humidity (RH) and the absolute humidity (AH) will be displayed alternatively.
10064	W	Modbus address
10065	W	Buzzer silencing time, in minutes, for the quantity #1
10066	W	Buzzer silencing time, in minutes, for the quantity #2
10067	W	Buzzer silencing time, in minutes, for the quantity #3
10068	W	Buzzer silencing time, in minutes, for the quantity #4
10069	W	Buzzer silencing time, in minutes, for the quantity #5
10070	W	Buzzer silencing time, in minutes, for the quantity #6
10077	B	Current range of the analog output 1: 0=0...20 mA, 1=4...20 mA
10078	B	Voltage range of the analog output 1: 0=0...10 V, 1=0...5 V
10079	SW	Value of the quantity associated with the analog output 1 corresponding to 0/4 mA and 0 V
10080	SW	Value of the quantity associated with the analog output 1 corresponding to 20 mA and 5/10 V
10081	W	Analog output 1 test register: the current output goes to the value, in tenths of mA, entered in the register (e.g., enter 120 for 12.0 mA). Set -1 to exit the test mode.
10082	W	Analog output 1 test register: the voltage output goes to the value, in tenths of V, entered in the register (e.g., enter 50 for 5.0 V). Set -1 to exit the test mode.
10083	B	Current range of the analog output 2: 0=0...20 mA, 1=4...20 mA
10084	B	Voltage range of the analog output 2: 0=0...10 V, 1=0...5 V
10085	SW	Value of the quantity associated with the analog output 2 corresponding to 0/4 mA and 0 V
10086	SW	Value of the quantity associated with the analog output 2 corresponding to 20 mA and 5/10 V
10087	W	Analog output 2 test register: the current output goes to the value, in tenths of mA, entered in the register (e.g., enter 120 for 12.0 mA). Set -1 to exit the test mode.
10088	W	Analog output 2 test register: the voltage output goes to the value, in tenths of V, entered in the register (e.g., enter 50 for 5.0 V). Set -1 to exit the test mode.
10089	B	Current range of the analog output 3: 0=0...20 mA, 1=4...20 mA
10090	B	Voltage range of the analog output 3: 0=0...10 V, 1=0...5 V
10091	SW	Value of the quantity associated with the analog output 3 corresponding to 0/4 mA and 0 V
10092	SW	Value of the quantity associated with the analog output 3 corresponding to 20 mA and 5/10 V
10093	W	Analog output 3 test register: the current output goes to the value, in tenths of mA, entered in the register (e.g., enter 120 for 12.0 mA). Set -1 to exit the test mode.
10094	W	Analog output 3 test register: the voltage output goes to the value, in tenths of V, entered in the register (e.g., enter 50 for 5.0 V). Set -1 to exit the test mode.
10095	W	Period, in minutes, of the auto-calibration of the zero of the differential pressure



Address	Type	Holding Register description
da 20000 a 20011	B	User code with ASCII codification of the quantity #1.
da 20012 a 20023	B	User code with ASCII codification of the quantity #2.
da 20024 a 20035	B	User code with ASCII codification of the quantity #3.
da 20036 a 20047	B	User code with ASCII codification of the quantity #4.
da 20048 a 20059	B	User code with ASCII codification of the quantity #5.
da 20060 a 20071	B	User code with ASCII codification of the quantity #6.
<b>Measurement alarm hysteresis and delay time</b>		
30002	B	<b>RH</b> alarm hysteresis in % (x10).
30003	B	RH alarm delay time in seconds.
30004	B	<b>DEW POINT</b> alarm hysteresis in the set measurement unit (x10).
30005	B	Dew point alarm delay time in seconds.
30010	B	<b>ABSOLUTE HUMIDITY</b> alarm hysteresis in g/m <sup>3</sup> (x10).
30011	B	Absolute humidity alarm delay time in seconds.
30012	B	<b>WET BULB TEMPERATURE</b> alarm hysteresis in the set measurement unit (x10).
30013	B	Wet bulb temperature alarm delay time in seconds.
30084	B	<b>DIFFERENTIAL PRESSURE</b> alarm hysteresis in the set measurement unit (the multiplier depends on the set unit).
30085	B	Differential pressure alarm delay time in seconds.
30174	B	Alarm hysteresis for <b>TEMPERATURE</b> with 4-wire Pt100 sensor of the T/RH combined probe in the set measurement unit (x100).
30175	B	Alarm delay time for temperature with 4-wire Pt100 sensor of the T/RH combined probe in seconds.

## 11 TECHNICAL CHARACTERISTICS

<b>Differential Pressure</b>	
<b>Sensor</b>	Piezoresistive
<b>Measuring range</b>	± 125 Pa
<b>Resolution</b>	0.01 Pa
<b>Accuracy</b>	± 0.35% typ. of measuring span (2 x full scale pressure)
<b>Zero drift</b>	Self-calibration
<b>Temperature drift</b>	±0.5% typ. of measuring span (2 x full scale pressure)
<b>Units of measurement</b>	Pa, mmH <sub>2</sub> O, mbar, inH <sub>2</sub> O, mmHg, hPa
<b>Connection</b>	∅ 6 mm barbed inputs
<b>Overpressure</b>	24.9 kPa
<b>Type of fluid</b>	Air and neutral gases
<b>Temperature (optional)</b>	
<b>Sensor</b>	4-wire Pt100
<b>Measuring range</b>	-40...+150 °C
<b>Resolution</b>	0.01 °C
<b>Accuracy</b>	1/3 DIN
<b>Stability</b>	0.1 °C/year
<b>Relative Humidity (optional)</b>	
<b>Sensor</b>	Capacitive
<b>Measuring range</b>	0...100 %RH
<b>Resolution</b>	0.1 %RH
<b>Accuracy</b>	± 1.8 %RH (0..85 %RH) / ± 2.5 %RH (85..100 %RH) @ T=15...35°C ± (2 + 1.5% of the measure)% @ T=remaining range
<b>Sensor operating temperature</b>	-20...+80 °C
<b>Response time</b>	T <sub>90</sub> < 20 s (air speed = 2 m/s, without filter)
<b>Temperature drift</b>	±2% in all the operating temperature range
<b>Stability</b>	1%/year

<b>General characteristics</b>	
<b>Display</b>	Red electroluminescent
<b>Keyboard</b>	Yes (4 keys)
<b>Configuration</b>	Via front keys, USB or ETHERNET connection to a PC and RS485 Modbus connection
<b>Alarm</b>	Buzzer on, LED lighting and sending of e-mails
<b>Analog output</b>	3 x 0/4...20 mA (active, max. load 500 Ω) or 3 x 0...5/10 V (min. load 10 kΩ) galvanically isolated
<b>USB</b>	Yes, HID type (no USB drivers) with front Mini-USB type B connector
<b>RS485</b>	Yes, with Slave Modbus-RTU protocol
<b>Ethernet</b>	Yes, RJ45 connector
<b>Wi-Fi</b>	<b>Optional</b> , IEEE 802.11b/g/n Frequency 2.4 GHz Security settings WEP64, WEP128, WPA, WPA2
<b>Web server</b>	Yes, for configuration and viewing the real time measurements
<b>Protocols</b>	Proprietary, Modbus-RTU, Modbus TCP/IP, SMTP, FTP, HTTP, NIST
<b>Measuring interval</b>	1, 2, 5, 10, 15, 30 s / 1, 2, 5, 10, 15, 30, 60 min
<b>Logging interval</b>	1, 2, 5, 10, 15, 30 s / 1, 2, 5, 10, 15, 30, 60 min
<b>Internal memory</b>	Circular management or stop logging if memory is full. Number of storable samples from 420,940 to 906,640 to depending on the number of quantities selected for logging.
<b>Power supply</b>	24 Vac / Vdc ± 10%
<b>Power consumption</b>	5 W
<b>Electrical connections</b>	Screw terminal block (max. 1.5 mm <sup>2</sup> / AWG16 cables)
<b>Operating temperature</b>	-10...+50 °C
<b>Storage temperature</b>	-10...+70 °C
<b>Housing material</b>	Stainless steel (AISI 316 front panel)
<b>Weight</b>	640 g approx.
<b>Installation</b>	Flush-mount
<b>Protection degree</b>	IP 65 (front panel, with protective cap on USB connector)

**Dimensions (mm):**

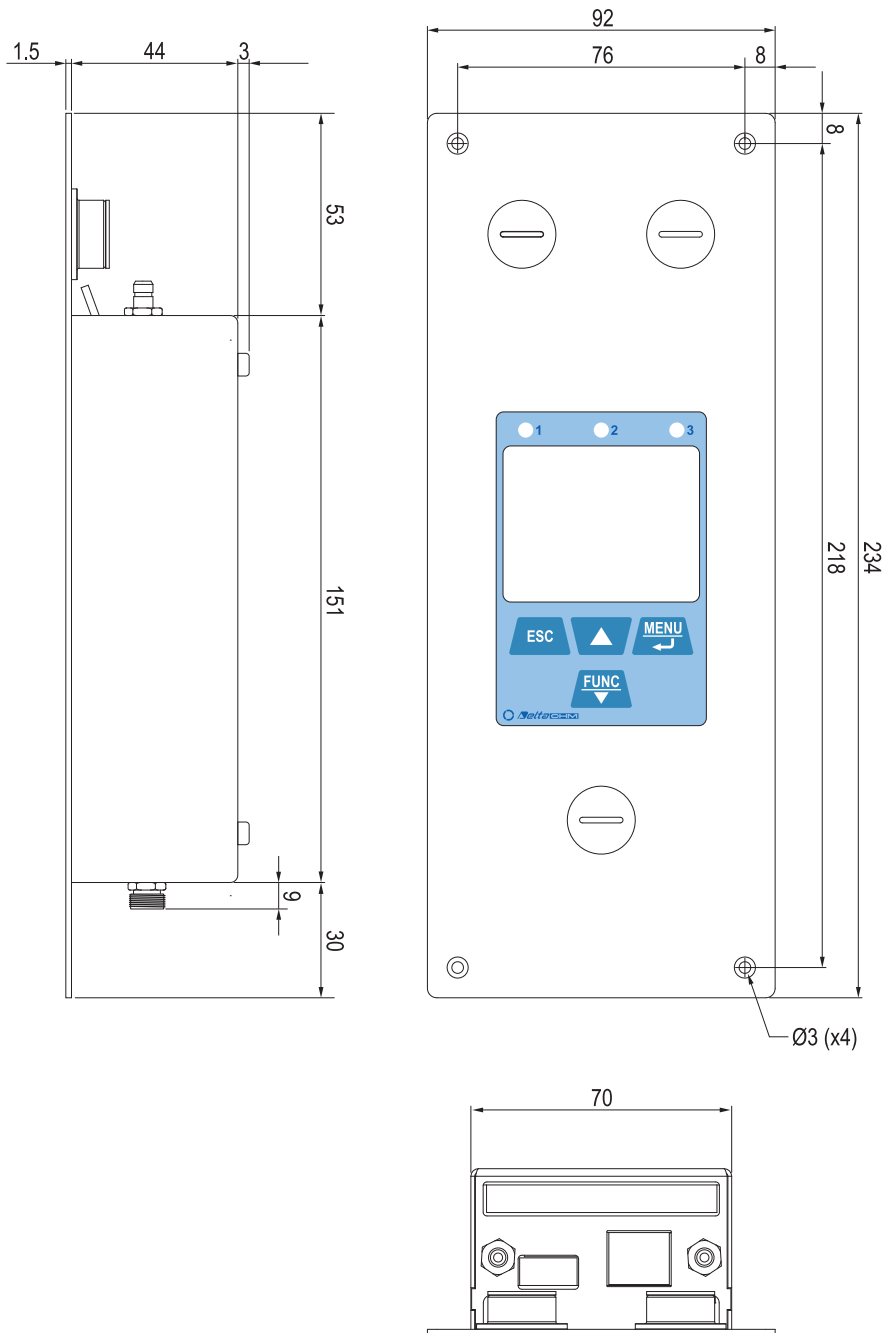

## 12 INSTRUMENT STORAGE

Conditions for storage of the instrument:

- Temperature: -10...+70 °C.
- Humidity: below 90 %RH no condensation.
- When storing, avoid places where:
  - humidity is high;
  - instrument is exposed to direct solar radiation;
  - instrument is exposed to high temperature source;
  - there are strong vibrations;
  - there is vapor, salt and/or corrosive gas.

## 13 SAFETY INSTRUCTIONS

### General safety instructions

The instrument has been manufactured and tested in compliance with the safety standard EN61010-1:2010 "Safety requirements for electrical equipment for measurement, control and laboratory use" and left the factory in a safe and secure technical condition.

The proper operation and the operational safety of the instrument can be ensured only if all the regular security measures are observed as well as the specific measures described in this operating manual.

The proper operation and the operational safety of the instrument can be ensured only under the climatic conditions specified in this manual.

Do not use the instrument in places where there are:

- Rapid ambient temperature variations that may cause condensation.
- Corrosive or flammable gases.
- Direct vibrations, shocks to the instrument.
- High-intensity electromagnetic fields, static electricity.

If the instrument is moved from a cold environment to a hot one or vice versa, the formation of condensation might cause problems to its operation. In this case you need to wait for the instrument temperature to reach ambient temperature before operation.

### User obligations

The user of the instrument must make sure that the following regulations and directives related to the handling of hazardous materials are fulfilled:

- European directives on safety and health at work.
- National regulations on safety and health at work.
- Accident prevention regulations.

## 14 PROBES AND ACCESSORIES ORDERING CODES

**HP3517E...** Temperature and relative humidity combined probe. Pt100 temperature sensor. Measuring range: 0...100 %RH, -40...+150 °C. 8-pole M12 female connector.

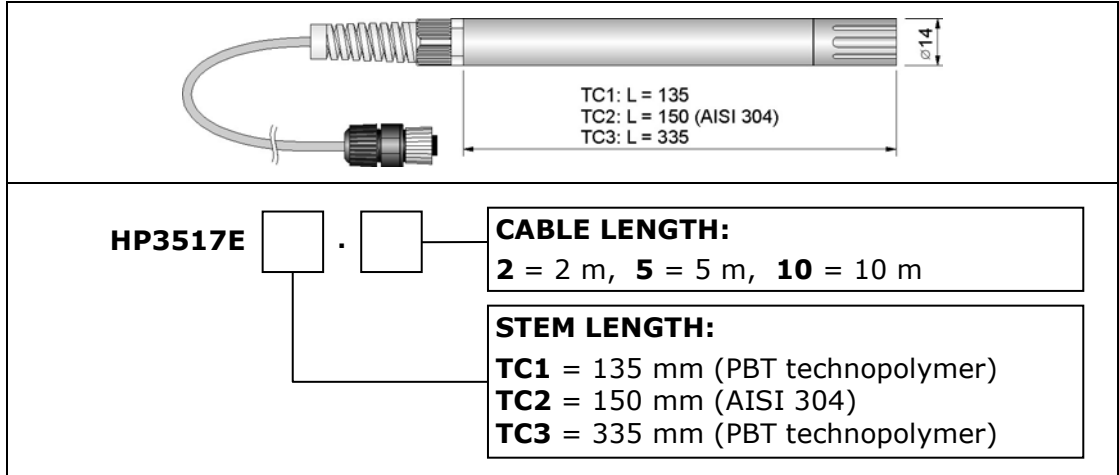

**HD35AP-CFR21** Software option that adds to the features of the basic software (both HD35AP-S and HDServer1), the management of the data in accordance with the **FDA 21 CFR part 11 recommendations**.

**HD75** Saturated solution to check Relative Humidity probes at 75 % RH, includes ring adapter for 14 mm diameter probes, thread M12×1.

**HD33** Saturated solution to check Relative Humidity probes at 33 % RH, includes ring adapter for 14 mm diameter probes, thread M12×1.

**HD11** Saturated solution to check Relative Humidity probes at 11 % RH, includes ring adapter for 14 mm diameter probes, thread M12×1.

**DELTA OHM metrology laboratories LAT N° 124 are ISO/IEC 17025 accredited by ACCREDIA for Temperature, Humidity, Pressure, Photometry / Radiometry, Acoustics and Air Velocity. They can supply calibration certificates for the accredited quantities.**

## Approvals

---

### IEEE 802.11 (Wi-Fi) certifications:

HD50CR contains IEEE 802.11b/g/n module FCC ID: XM5-SMG2N2  
IC ID: 8516A- SMG2N2  
TELEC certified RF module: [R] 204-520077



## FCC and IC notices

---

**Notice:** This device complies with Part 15 -15.247(a2) and 15.247(b) and 15.249 of the FCC Rules and with Industry Canada (IC) licence-exempt RSS standard(s). Operation is subject to the following two conditions: (1) this device may not cause harmful interference, and (2) this device must accept any interference received, including interference that may cause undesired operation.

**Avis:** *Cet appareil est conforme avec Part 15 -15.247(a2) et 15.247(b) et 15.249 des règlements FCC et Industrie Canada (IC) RSS standard exempts de licence(s). Son fonctionnement est soumis aux deux conditions suivantes: (1) cet appareil ne peut pas provoquer d'interférence et (2) cet appareil doit accepter toute interférence, y compris les interférences qui peuvent causer un mauvais fonctionnement du dispositif.*

**Notice:** This equipment has been tested and found to comply with the limits for Class B digital device, pursuant to part 15 of the FCC Rules. These limits are designed to provide reasonable protection against harmful interference in a residential installation. This equipment generates, uses and radiates radio frequency energy, and, if not installed and used in accordance with the instructions, may cause harmful interference to radio communications. However, there is no guarantee that interference will not occur in a particular installation. If this equipment does cause harmful interference to radio or television reception, which can be determined by turning the equipment off and on, the user is encouraged to try to correct the interference by one or more of the following measure:

- Reorient or relocate the receiving antenna.
- Increase the separation between the equipment and receiver.
- Connect the equipment into an outlet on a circuit different from that to which the receiver is connected.
- Consult the dealer or an experienced radio/TV technician for help.

**Notice:** To satisfy FCC/IC RF exposure requirements for mobile and base station transmission devices, a separation distance of 20 cm or more should be maintained between the antenna of this device and persons during operation. To ensure compliance, operation at closer than this distance is not recommended. The antenna(s) used for this transmitter must not be co-located or operating in conjunction with any other antenna or transmitter.

**Avis:** *Pour répondre aux exigences d'exposition RF FCC/IC pour les dispositifs de transmission mobiles et les stations de base, une distance de séparation de 20 cm ou plus doit être maintenue entre l'antenne de l'appareil et des personnes en cours de fonctionnement. Pour assurer la conformité, l'exploitation de plus près à cette distance n'est pas recommandée. L'antenne(s) utilisé pour cet émetteur ne doit pas être co-localisés ou fonctionner conjointement avec une autre antenne ou transmetteur.*

**Notice:** Under Industry Canada regulations, this radio transmitter may only operate using an antenna of a type and maximum (or lesser) gain approved for the transmitter by Industry Canada. To reduce potential radio interference to other users, the antenna type and its gain should be so chosen that the equivalent isotropically radiated power (e.i.r.p.) is not more than that necessary for successful communication.

**Avis:** *Conformément à la réglementation d'Industrie Canada, le présent émetteur radio peut fonctionner avec une antenne d'un type et d'un gain maximal (ou inférieur) approuvé pour l'émetteur par Industrie Canada. Dans le but de réduire les risques de brouillage radioélectrique à l'intention des autres utilisateurs, il faut choisir le type d'antenne et son gain de sorte que la puissance isotrope rayonnée équivalente (p.i.r.e.) ne dépasse pas l'intensité nécessaire à l'établissement d'une communication satisfaisante.*



**NOTES**

---

**NOTES**

---

## NOTES

---

## WARRANTY

The manufacturer is required to respond to the "factory warranty" only in those cases provided by Legislative Decree 6 September 2005 - n. 206. Each instrument is sold after rigorous inspections; if any manufacturing defect is found, it is necessary to contact the distributor where the instrument was purchased from. During the warranty period (24 months from the date of invoice) any manufacturing defects found will be repaired free of charge. Misuse, wear, neglect, lack or inefficient maintenance as well as theft and damage during transport are excluded. Warranty does not apply if changes, tampering or unauthorized repairs are made on the product. Solutions, probes, electrodes and microphones are not guaranteed as the improper use, even for a few minutes, may cause irreparable damages.

The manufacturer repairs the products that show defects of construction in accordance with the terms and conditions of warranty included in the manual of the product. For any dispute, the competent court is the Court of Padua. The Italian law and the "Convention on Contracts for the International Sales of Goods" apply.

## TECHNICAL INFORMATION

The quality level of our instruments is the result of the continuous product development. This may lead to differences between the information reported in the manual and the instrument you have purchased.

We reserves the right to change technical specifications and dimensions to fit the product requirements without prior notice.

## DISPOSAL INFORMATION

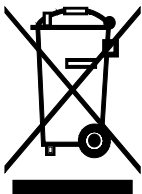

Electrical and electronic equipment marked with specific symbol in compliance with 2012/19/EU Directive must be disposed of separately from household waste. European users can hand them over to the dealer or to the manufacturer when purchasing a new electrical and electronic equipment, or to a WEEE collection point designated by local authorities. Illegal disposal is punished by law.

Disposing of electrical and electronic equipment separately from normal waste helps to preserve natural resources and allows materials to be recycled in an environmentally friendly way without risks to human health.

CE RoHS



**senseca**

**Please note our new name:**  
Senseca Italy Srl  
Via Marconi 5, 35030 Padua, Italy  
*Documents are in the process of being changed.*